



April 2024

Mobileye 8 series

Technical Installation guide v3.7

Models:

Mobileye 8 Connect 4G

Mobileye 8 NC

Mobileye 8 SA

Table Of Contents

Table Of Contents	1
1. Warnings	4
1.1 General	4
1.2 Mobileye 8 Series supported models	5
1.2 Installation & Safety Instructions	5
2. Components Overview (* supplied in 2 separate boxes)	6
3. Software downloads & installation	8
4. Connection Scheme	9
4.1 CAN-bus Installation Scheme	9
4.2 Mixed Installation Scheme (Analog + CAN-bus)	10
	10
5. Connection Description	11
5.1 Introduction	11
5.2 Main unit connections (CAB000400 Rev3.3)	11
5.3 Mobileye 8 Series signals cable (CAB000371 Rev6.3)	11
5.4 CE Module (ASY00000000000518)	13
5.4.1 CE Module overview	13
5.4.1 CE Module connection instruction	13
5.5 Ferrite Component	14
5.5.1 Ferrite for Power Sources -Model 1 (ITM000786)	14
5.5.2 Instructions for power sources (CE Module)	14
5.5.3 Ferrite for Power Sources -Model 1 (CE Module)	14
5.6 EyeWatch 3 – display and control unit (CAB000087) -OPTION 1	15
5.7 EyeWatch 8 – display and control unit (CAB000401) -OPTION 2	15
5.8 CAN Reader – CAB000302	16
5.9 EyeNET – (EYENET0001 / CAB000613)	16
6. Connection Description	17
6.1 Site preparation	17
6.2 Vehicle signals connections	17

6.3 EyeWatch Installation	18
6.4 Mobileye 8 series main unit (camera) installation.	19
6.5 Installing the Mobileye 8 series* 4G modem	21
7. 4G Cable Ferrite Installation	22
7.1 Instructions for 4G cable Ferrite installation	22
7.2 Mobileye 8 Series 4G Connection Scheme	23
8. Installation & Calibration	24
8.1 Back-Cover removal	24
8.2 Communication / Connection phase	25
8.3 System Calibration	26
8.3.1 Login	26
8.3.2 Login	27
8.3.3 Vehicle Selection	29
8.3.4 Connection to SeeQ	30
8.3.5 Vehicle Information	Error! Bookmark not defined.
8.3.6 Vehicle Information	31
8.3.7 Analog Installation	32
8.3.8 Signal Test	33
8.3.8.1 Signal Test Troubleshooting	34
8.3.9 Calibration	36
8.3.9.1 Step 1 – TAC assembly	36
8.3.9.2 Step 2 – Camera attachment	37
9. GPS attachment	38
9.1 Step 3 – GPS attachment	38
9.2 GPS attachment location allowed areas.	39
10. Step 4 – Measurements	41
11. Step 5 – Camera angle adjustment	46
11.1 Step 6 – Car hood	46
11.2 Step 7 – Calibration	47
12. Validation	50
10.1 General	50

10.2 Operation	50
13. Appendix A – 4G Modem	52
13.1 Modem Status	52
13.2 Technical Spec	52
14. Appendix A – CAN Reader	53
14.1 General	53
14.2 CAN Reader installation (CAB000302)	53
15. Appendix B – up/down configuration	54
15.1 General	54
15.2 Up/down configuration – old chassis MEC000956	56
15.3 Up/down configuration – new chassis MEC000116	58
16. Appendix C – EyeNET Holder (ASY000451)	60
16.1 Introduction	60
16.2 Component Overview	60
16.3 Assembly	60
17. Appendix D – Calibration Tool	62
17.1 Intro	62
17.2 Instructions	62
18. Troubleshooting	64
19. Technical Specification	65
19.1 Mobileye® 8 Series™ – 4G Technical Specification Sheet	65
19.2 Mobileye® 8 series™ – 4G Display unit Specification Sheet	66
19.3 Mobileye® 8 series™ – 4G Cellular Module Specification Sheet	67
19.4 Mobileye® 8 series™ – 4G GNSS Technical Specification	68
19.5 Mobileye® 8 series™ – 4G Certificates.	Error! Bookmark not defined.

1. Warnings

1.1 General

Mobileye 8 Series is Mobileye's new driver assistance system, containing the latest iteration in Mobileye's state-of-the-art machine vision software – the EyeQ®4 system-on-chip.

Mobileye 8 Series alerts the driver, aurally and visually, to certain potentially dangerous situations on the road: the greater the danger, the more 'urgent' the warning.

Mobileye 8 Series is not an automated driving system. It does not replace the driver nor allow the driver to be any less vigilant or alert to the road than he/she would otherwise be. It does not reduce the driver's responsibility for driving properly, nor his/her liability for driving improperly or unlawfully. In particular, the driver should ensure not to be distracted from the road by the Mobileye 8 Series display unit.

Mobileye 8 Series works best on paved roads with clear lane markings. Even then, Mobileye cannot guarantee 100% accuracy nor the absence of false positives ('seeing' something that's not there) or false negatives (failing to 'see' something that is there), especially in adverse road or weather conditions.

Mobileye 8 Series is designed to detect only fully visible vehicles and fully visible pedestrians and bicycles (both in daylight and at night). It is not designed to detect crossing, oncoming, or passing vehicles.

Warning

- ✓ Do not connect any system component when vehicle power is On.
- ✓ All system components must be connected before turning the system power On.
- ✓ Before making the power connections, extract the Fuse from the Fuse holder and add it back only after all system components and cables are connected and before turning the vehicle power On.
- ✓ DO NOT open the SIM card lid while system is On. Replacing the SIM card is prohibited.

1.2 Mobileye 8 Series supported models.

Mobileye 8 Connect 3G, Mobileye 8 Connect 4G, Mobileye 8 SA, Mobileye 8 NC

Master ME8 NC (Not Connected)

ME800000000VSSNC

ME800000VSSNCALL

ME880000000VSSNC

Master ME8 4G

ME800000000VSM4G

ME880000000VSM4G

1.2 Installation & Safety Instructions

- ✓ Mobileye 8 Series installation must be carried out by an authorized Mobileye 8 Series dealer or Installer.
- ✓ Do not transfer Mobileye 8 Series to another vehicle after installation.
- ✓ The Mobileye 8 Series GSM Nano SIM card will work only with the supported Mobileye 8 models with which it is supplied; do not use the SIM for other purposes or with other Mobileye 8 Series units.
- ✓ Operate Mobileye 8 Series only with 12VDC~24VDC power.
- ✓ Do not cover or obstruct the Camera Unit or Display and Control Unit.
- ✓ Use proper tools.
- ✓ Use only an LED voltage tester or digital multi meter. Do not use a light bulb voltage tester.
- ✓ Pay attention to unusual color cables, for example: yellow cables belong to air bags; two twisted wires usually belong to different (digital) sensors.
- ✓ Before disconnecting the battery or radio connectors make sure to have the radio code in hand.
- ✓ Do not disconnect any plug or connector in the vehicle while the car's ignition switch is on.
- ✓ Before making the power connections, extract the Fuse from the Fuse holder and add it back only after all system components and cables are connected and before turning the vehicle power On.
- ✓ **Use protective gloves when handling the camera unit to protect against heat burns.**

2. Components Overview (* supplied in 2 separate boxes)

Package List	Component	Mobileye P/N	Mobileye 8 Connect 4G	Mobileye 8 NC	Mobileye 8 SA
Master Camera unit		ME800000VSSNCALL ME8800000000VSSNC ME8000000000VSSNC ME8000000000ETH4G ME8000000000VSM4G ME8800000000VSM4G	✓	✓	✓
Main cable		CAB000400	✓	✓	✓
Display unit – EyeWatch 3		ASY000130	✓	✓	
Display unit – EyeWatch 8 (Optional)		PAC0000000000EW8			✓
CANReader		CAB000302	✓	✓	✓
Signals cable		CAB000371	✓	✓	✓
External fuse holders with 2A fuses		Fuse - ITM000205 Fuse holder (Red) - ITM000206 Fuse holder (Blue) - ITM000207	✓	✓	✓
3M VHB Surface Cleaner		ITM000024	✓	✓	✓
4G Modem		PAC0000AJMODEM4G PAC0000CHMODEM4G PAC0000EUMODEM4G PAC0000INMODEM4G PAC0000NAMODEM4G PAC0000LAMODEM4G	✓		
External GPS Antenna		ASY000961	✓		✓
Ferrite for 4G modem		ITM000788	✓		
Ferrite for Power sources		ITM000786	✓	✓	✓
CE Module* <small>*The CE module is required only in CE regulated territories. Not required in North America.</small>		PAC00ME8CEFILTER	✓		

Please be aware that certain product numbers (PN) may include or exclude specific components from the kit.

Installer Kit			
EyeNET		Used for system installation, calibration & configuration	EyeNET0001
TAC		used for both the main camera attachment to the windshield (reference point) and for calibration calculation	TACS00003

(i) Note

The Mobileye EyeNET and TAC are not part of the Mobileye 8 Series kit and are sold separately.

3. Software downloads & installation

Mobileye 8 Series uses a dedicated applications for configuration and calibration*.

The applications are part of the **Mobileye Installation Center**.

The software installer is available in our website under "support" tab or in the following direct link:

<https://www.mobileye.com/support/>

Note

Please make sure you have Administrator Privileges before installing the Mobileye IC application, if not, please contact your IT department for further assistance.

Note

To keep the most up to date version of the IC application, login with your login details to enable to automatic update. If an update is available, follow the on-screen

4. Connection Scheme

4.1 CAN-bus Installation Scheme

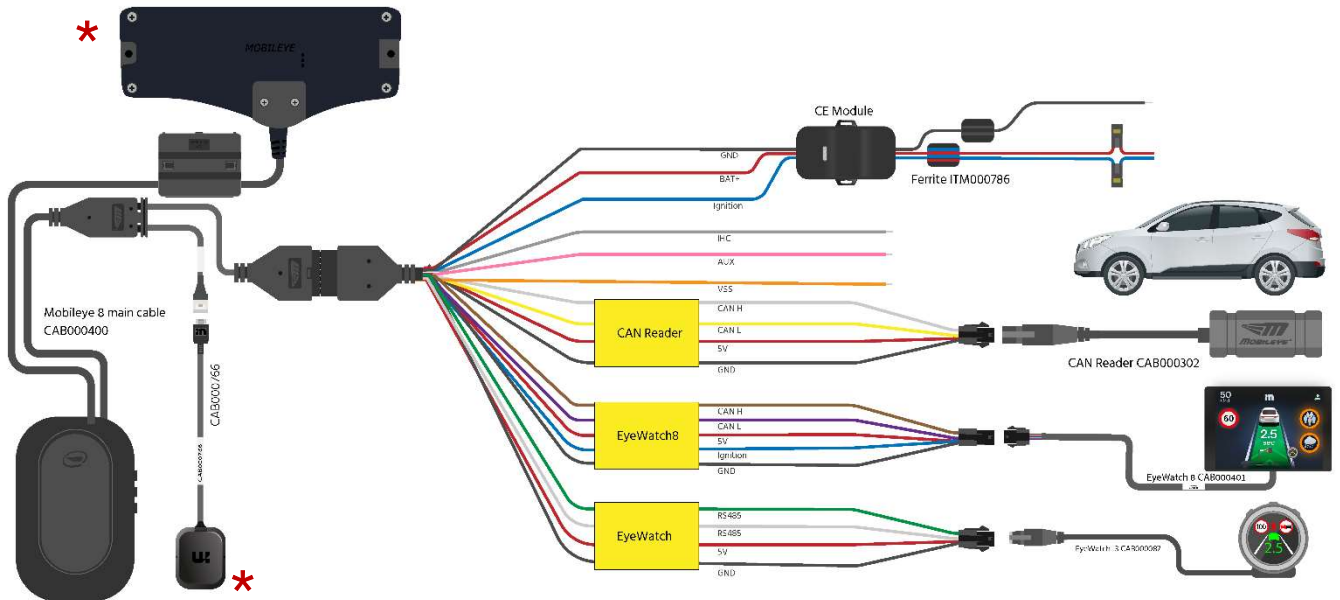

The CE module is required only in CE regulated territories.

*For Mobileye 8 Series Mobileye 8 Connect 4G

4.2 Mixed Installation Scheme (Analog + CAN-bus)

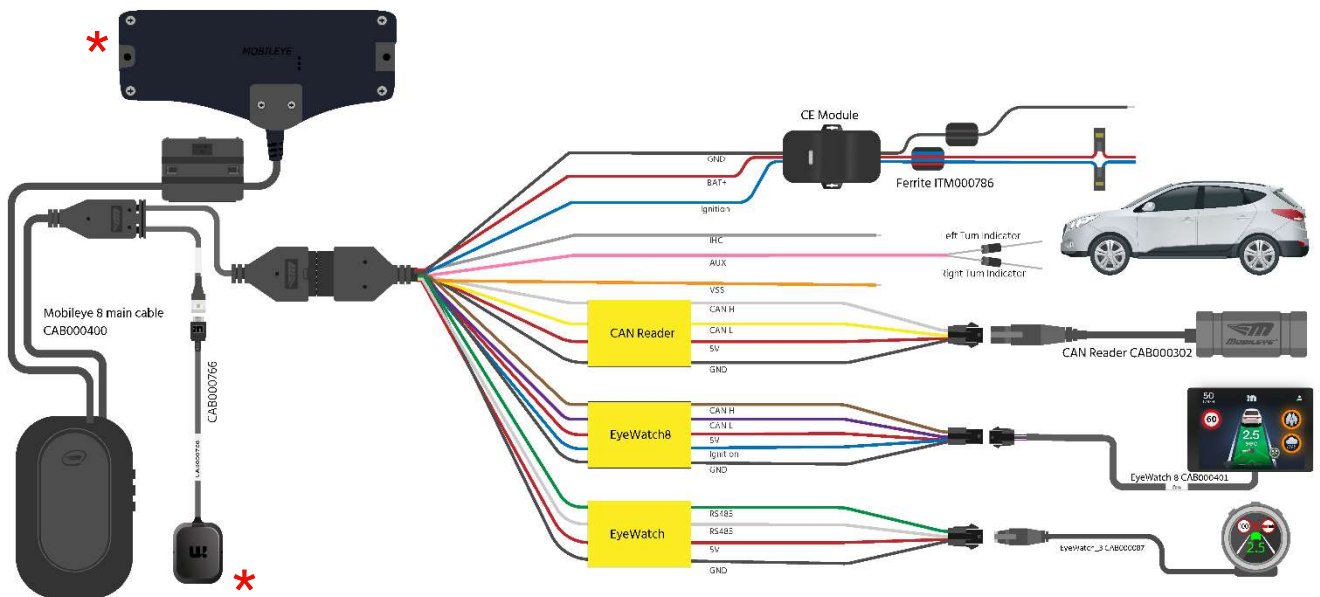

The CE module is required only in CE regulated territories.

* For Mobileye 8 Series Mobileye 8 Connect 4G

Analog Installation Scheme

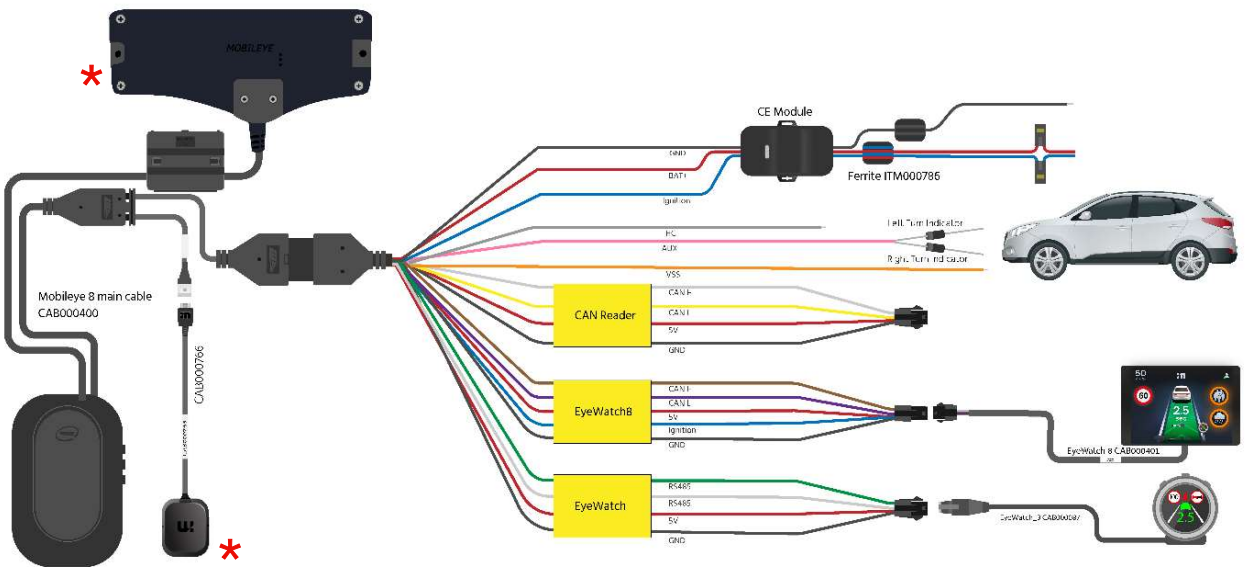

The CE module is required only in CE regulated territories.

* For Mobileye 8 Series Mobileye 8 Connect 4G

5. Connection Description

5.1 Introduction

The following paragraphs describe in detail the function and connections of the system’s components.

5.2 Main unit connections (CAB000400 Rev3.3)

Wire Name & Function	Wire color	Connector	Connection To
Signals - (14 pin connector)	Black	J1	Vehicle signals cable (CAB000371 rev.6.3)
GPS - (5 pins White connector)	Black	P2	GPS Module and extension cable CAB00402 Rev 1.1

Table 1: Mobileye 8 Series cable connections.

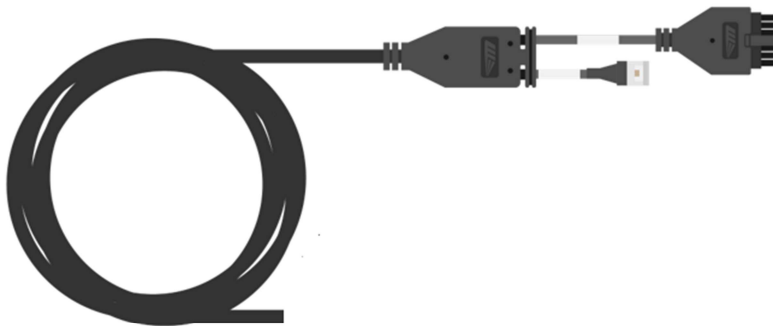

5.3 Mobileye 8 Series signals cable (CAB000371 Rev6.3)

The Mobileye 8 series signals cable splits into a few cables which connect to the vehicle power source, to the vehicle CAN-bus (Via CAN Reader connector) , to the vehicle analog speed signal, to the vehicle high-beams (for LHC), to one of the vehicle’s analog signals if required (or both analog left- and right-turn indicator signals via diode), to the EyeWatch display unit (via 4 pin male connector labeled as "EyeWatch" and it contains a 6-pin female connector labeled "EyeWatch 8" to provide future connection for new EyeWatch unit.

A detailed description of each of the wires in the analog cable can be found in the following table below:

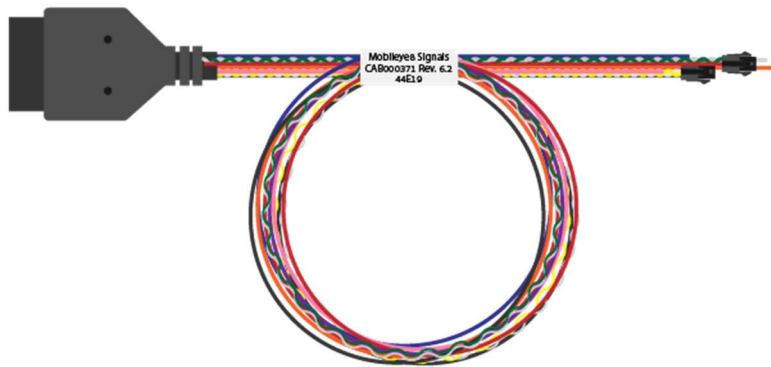

Wire Name & Function	Wire color	Connector	Connection To
BAT+ (12/24V)	Red	-	Vehicle`s constant power (Battery) – via CE Module
GND	Black	-	Vehicle`s GND (BAT-) - via CE Module
Ignition (12/24V)	Blue	-	Vehicle`s ignition signal - via CE Module
CANBH	White	4pin	CAN Reader
CANBL	Yellow	4pin	CAN Reader
5V for CAN Reader	Red	4pin	CAN Reader
GND for CAN Reader	Black	4pin	CAN Reader
VSS	Orange	-	Vehicle`s Analog speed signal
CAN A High	Purple	6pin	EyeWatch 8
CAN A Low	Brown	6pin	EyeWatch 8
5V for EyeWatch 8	Red	6pin	EyeWatch 8
GND for EyeWatch 8	Black	6pin	EyeWatch 8
AUX (Analog Input)	Pink	-	1 analog signal input (or both Left and Right Turn indicators analog input via Diode)
IHC – (Analog Output)	Gray	-	Vehicle`s high beams via external relay or connection to any 3 rd party device
RS-485 High	Green	4pin	EyeWatch 3
RS-485 Low	White	4pin	EyeWatch 3
RS-485 GND	Black	4pin	EyeWatch 3
RS-485 5V DC	Red	4pin	EyeWatch 3

Table 2: Mobileye 8 series analog signals cable connection.

5.4 CE Module (ASY0000000000518)

The CE module is required only in CE regulated territories.
The CE module is not required in North America.

5.4.1 CE Module overview

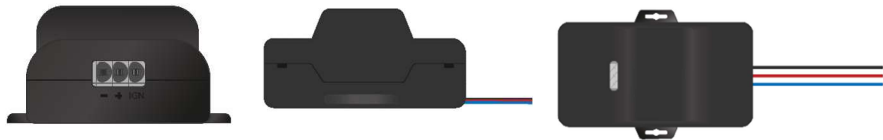

5.4.1 CE Module connection instruction

1. Press and hold the CE Module upper silicon (using a small screwdriver) to unlock the CE Module power source connector.

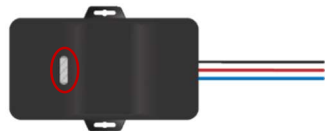

2. Insert each power source from CAB000371 to the dedicated power connection in the CE Module
3. When the wire inserts properly, release the upper silicon press to lock the wire in the connector.

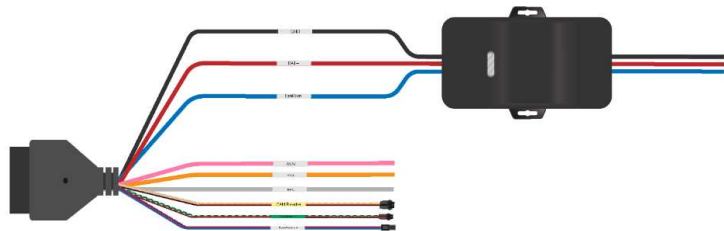

Note

- ✓ CE Module installation on power lines is mandatory in CE marking countries.
- ✓ CE Module installations are not mandatory for FCC and E-Mark certificates.

Warning

The CE Module is relevant to Mobileye 8 series installation only.

If you are installation Mobileye Shield Connect and/or FishEye system, DO NOT connect the CE Module and Ferrite on the Junction Box power lines.

5.5 Ferrite Component

5.5.1 Ferrite for Power Sources -Model 1 (ITM000786)

Note

The Ferrite size and shape may vary different between different Ferrite models.



5.5.2 Instructions for power sources (CE Module)

Please follow the instructions bellow for the two ferrites installation:

4. Place both Mobileye **BAT+** wire and **Ignition** wire (CE Module wires) together inside the first Ferrite.
5. Locate the Ferrite 5cm from the Mobileye CE Module
6. Wrap the **BAT+** and **Ignition** wires through the Ferrite **2** times and around the outside of the Ferrite **1** times, as shown in the figures
7. Place the Mobileye **GND** wire in the second Ferrite (locate the Ferrite filters 5cm from the Mobileye CE Module).
8. Wrap the GND wire through the Ferrite **2** times and around the outside of the Ferrite **1** times, as shown in the figures.

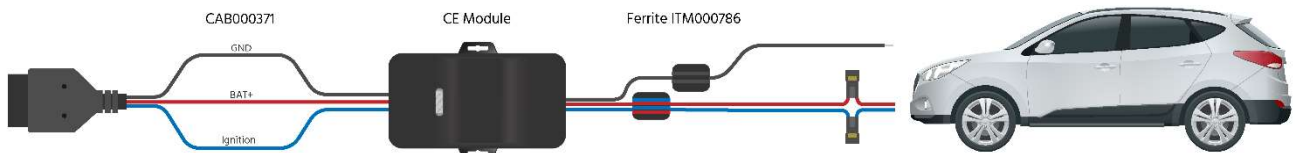
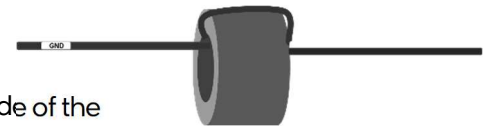
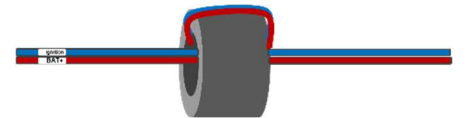

5.5.3 Ferrite for Power Sources -Model 1 (CE Module)

Warning

The Ferrite is relevant to Mobileye 8 Series installation only.

If you are installation Mobileye Shield Connect and/or FishEye system, **DO NOT** connect the Ferrite on the Junction Box power lines.

Note

The Ferrite size and shape may vary different between different Ferrite models.

5.6 EyeWatch 3 – display and control unit (CAB000087) -OPTION 1

The EyeWatch is connected to the Mobileye 8 series EyeWatch female connector (J1) using the EyeWatch connecting cable male connector (J1).

Table 3: EyeWatch connections

Wire name	Wire color	Connector	Connection to
EyeWatch Cable (CAB000087)	Black	J1 - Female	EyeWatch 4pin male connector in CAB000371
EyeWatch (CAB000371)	Black	J1 – Male	ME8 Signals cable 4 Pin connector for EyeWatch unit

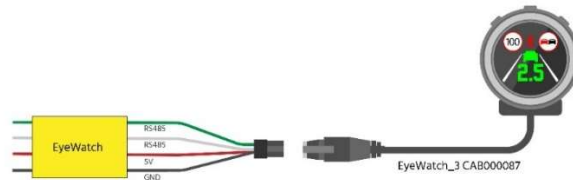

5.7 EyeWatch 8 – display and control unit (CAB000401) -OPTION 2

The EyeWatch 8 is connected to the Mobileye 8 series signals cable with the EyeWatch male connector (P1) to the Signals cable EyeWatch 8 female connector (P2).

Wire name	Wire color	Connector	Connection to
EyeWatch 8 Cable (CAB000401)	Black	P1 - Male	EyeWatch 6 pin female connector in CAB000371
EyeWatch (CAB000371)	Black	P2 – Female	ME8 Signals cable 6 Pin male connector for EyeWatch 8 unit

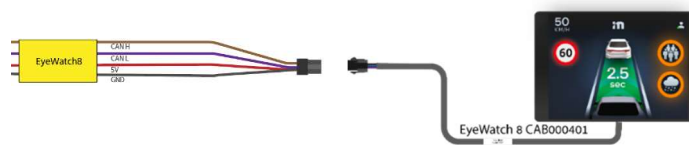

Note

- ✓ EyeWatch 8 is compatible with ME8 system firmware version 8.2.24 and higher
- ✓ EyeWatch 8 is compatible with the following ME8 cables:
- ✓ CAB000400 Rev3.3 and up.
- ✓ CAB000371 Rev6.3 and up.

5.8 CAN Reader – CAB000302

The Mobileye CAN-Reader is a non-intrusive solution for CAN-bus connection.

The Mobileye CAN Reader will allow you to better handle a CAN-bus reading by simply placing the Reader on the vehicle CAN-bus wires without any wire cutting or pinching.

Wire name	Wire color	Connector	Connection to
Power sources and signals cable (CAB000371)	Red, Black, Yellow and White	Male	Mobileye CAN Sensor
Mobileye CAN Sensor (CAB0003002)	Black	Female	Power sources and signals cable (CAB000371)



5.9 EyeNET – (EYENET0001 / CAB000613)

The Mobileye 8 series service port female connector (P2) is used to connect to the Mobileye EyeNET short cable male connector labeled “MOBILEYE8 SIDE” (J5).

Wire name	Wire color	Connector	Connection to
EyeNET short cable (BRD000350)	Brown	Male	Mobileye 8 series service port
EyeNET Ethernet LAN port		Female	LAN port for Ethernet cable between the EyeNET and the PC
Mobileye 8 series service port		Female	EyeNET cable

Table 4: EyeNET connections

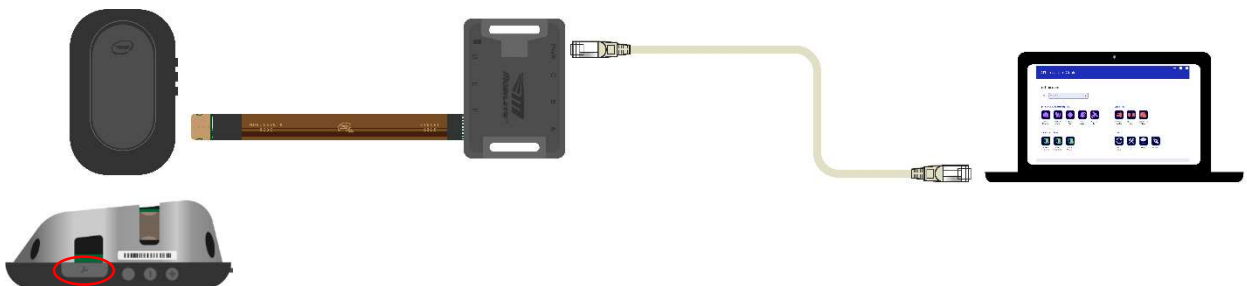

6. Connection Description

6.1 Site preparation

- ✓ Make sure the vehicle is parked on a flat surface (no slope).



- ✓ Check vehicle speed signal availability (either by CAN-bus or by Analog) to determine which type of installation will be for the Master camera (CAN, Analog, Mix).

6.2 Vehicle signals connections

Warning

Identifying the vehicle's electrical signals requires having the keys in the ignition in the ACC (Accessory) position or ignition ON. Make sure the car headlights and/or any other power consuming devices/applications, e.g., air conditioning, are turned off during Mobileye 8 Connect installation to prevent battery drainage.

Please ensure to identify the Mobileye 8 series cables according to table below.

Identified vehicle's signals	Wires label	Wires color
Vehicle battery (Constant 12V~24V) via 2A fuse	BAT+	Red
Ignition (12V~24V) via 2A fuse	Ignition	Blue
Vehicle GND	GND	Black
CAN B High	CAN Reader	White
CAN B Low	CAN Reader	Yellow

6.3 EyeWatch Installation

Caution

- ❖ The EyeWatch unit should be placed in a location that does not obstruct the driver's field of vision.
- ❖ The EyeWatch should not be placed in front of the air-bags operational space as it may otherwise prevent the airbag from fully opening or cause injury during airbag activation.

Select the optimal location for the EyeWatch attachment:

1. The EyeWatch should be placed on the dashboard or windshield at a location within the driver's field of view, conveniently visible while driving, and allowing access to its controls while sitting comfortably in the driver's seat (the EyeWatch mounting angle is adjustable by the installer — a Philips's screwdriver is required)
2. Clean the selected location with the provided 3M VHB Surface cleaner.
3. Attach the EyeWatch at the selected place (after removing the protective cover from the adhesive tape)
4. Remove the transparent protecting covering from the display surface.
5. Insert the EyeWatch cable (CAB000087/CAB000401) behind the vehicle trimmings so that it reaches the EyeWatch connector of the Mobileye 8 series cable (CAB000400)



6.4 Mobileye 8 series main unit (camera) installation.

Warning

Selecting the optimal location for the main unit is critical and can affect system performance. Please ensure to comply with the following guidelines.

- ❖ Minimum height for camera location is 1.2 meters (3.9 feet).
Maximum height for camera location is 2.65 meter (8.69 feet) *.

Note

REM functionality may be compromised above camera height 1.8 meters.

- ❖ The unit must be in an area of the windshield which the windshield wipers reach.
- ❖ The unit should preferably be located at the center of the windshield.
Installing the unit off-center in a convex windshield will result an improper field of view, which will affect system performance. The camera's lens should always face straight ahead.
- ❖ Off-center installation is allowed up to 8%
EXAMPLE: if the vehicle width is 200cm (2M), camera can be attached up to 16 cm from the windshield center ($200 \times 0.08 = 16$). **Vehicle width in cm X 0.08 = MAX OFFSET**
- ❖ Camera roll-up is allowed up to 2°; if the camera roll is higher than 2°, the calibration will fail.
- ❖ There should be no obstruction, such as stickers or darkened windshield areas, in front of the main unit.
- ❖ In tall commercial vehicles that do not have an engine hood blocking the camera's field of view, the main unit can be placed on the lower part of the windshield; however, all the above-mentioned requirements must nonetheless be considered. In this case, you can modify the main unit cable to the "DOWN" position. "DOWN" means that after the main unit installation, the main cable exits from downwards instead of upwards (by default the cable exits upward from the "UP" position).

 Caution

- ❖ Attaching the camera unit to the windshield should take place only after receiving a live streaming video during calibration process.

The following paragraphs present the function of each cable and guide you through the actual connection procedures with the vehicle's signals.

1. Identify the wires in the vehicle that carry the required electrical signals (according to the table above).
2. After identifying the required signal's locations in the vehicle, pass the Mobileye 8 series cable (CAB000400) behind the vehicle trimmings so that it reaches all vehicle signals (it is recommended that you hang the Mobileye 8 series main unit on the rear-view mirror or place it on the dashboard before passing the cable behind the vehicle trimmings).
3. Firmly connect the appropriate wire from the Mobileye 8 series signals cable (CAB000371) to the identified vehicle signal.
4. Each wire in the Mobileye 8 series signals cable (CAB000371) mentioned above has a unique color. Make sure to connect the correct vehicle signal to its appropriate wire according to the table in page 12.
5. Keep the Mobileye 8 series EyeCAN connector & EyeWatch connectors easily accessible.

 Warning

- Connect each power source led to its appropriate connection in the vehicle.
- Make sure the 2A fuses are kept easily accessible.
- Wires colors are not guaranteed. Always double-check wires' labels
- Always check the Mobileye vehicle database for CAN-bus availability before installation is started.

6.5 Installing the Mobileye 8 series* 4G modem

Mobileye 8 Connect 4G uses an external 4G Modem for better cellular coverage.

The modem can be placed below the dashboard or any other location with enough space to accommodate it if there are not any Metal parts above the modem that may interrupt the reception. Use the tightening loops and a plastic tie to firmly position it.

To connect the 4G modem, please follow the next steps:

1. Route the 4G modem cable (CAB000405) to the destinated modem location.
2. Connect the model connector from the Modem side (see image below) and route the cable from the camera to the bottom of the dashboard through the trimming & A/B pillar.
3. Route the 4G modem cable and connect it to the 4G modem on the designated connector.
4. Make sure the silicone rubber secure in its place.
5. Close the 4G modem connector cover and close the 2 screws.

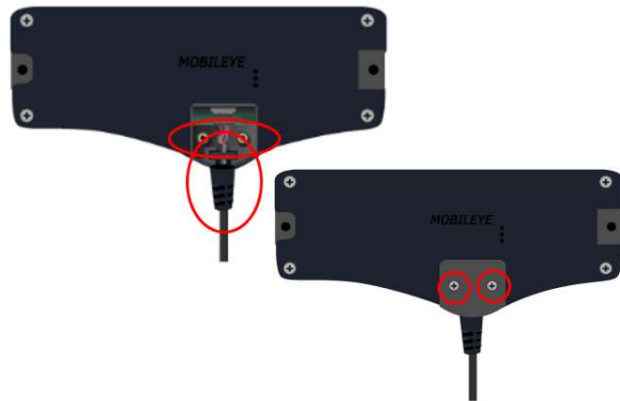

Warning

- Do not connect any system component when vehicle power is On.
- All system components must be connected before turning the system power On.
- Before making the power connections, extract the Fuse from the Fuse holder and put it back only after all system components and cables are connected and before turning the vehicle power On.

Note

The 4G Modem cable (CAB000405) can be routed either from the top side or the bottom side of the camera chassis (in case you have the new chassis MEC000116).
For more information, please see [Appendix B](#).

7. 4G Cable Ferrite Installation

Warning

Before making the power connections, extract the Fuse from the Fuse holder and add it back only after all system components and cables are connected and before turning the vehicle.

7.1 Instructions for 4G cable Ferrite installation

Note

Ferrite installation on Mobileye 8 series **ME80000000VSM4G & ME88000000VSM4G** 4G modem is mandatory.

Please follow the instructions bellow for the 4G Modem ferrites installation (ITM000788):

1. Put the Mobileye 4G Modem cable in the third Ferrite.
2. Wrap the cable through the Ferrite 2 times and around the outside of the Ferrite 1 time.

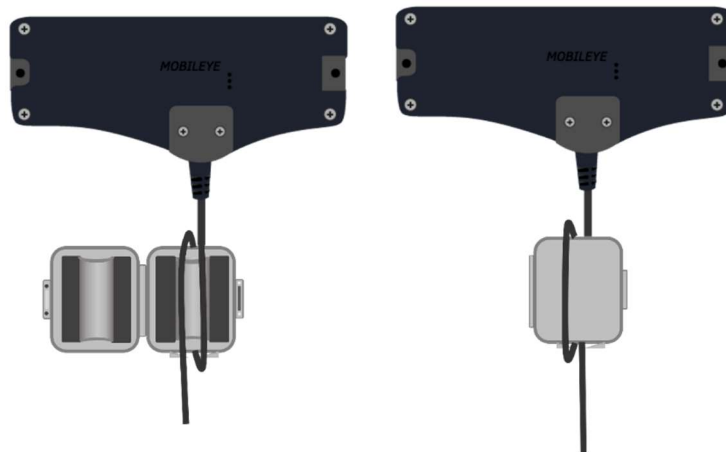

7.2 Mobileye 8 Series 4G Connection Scheme

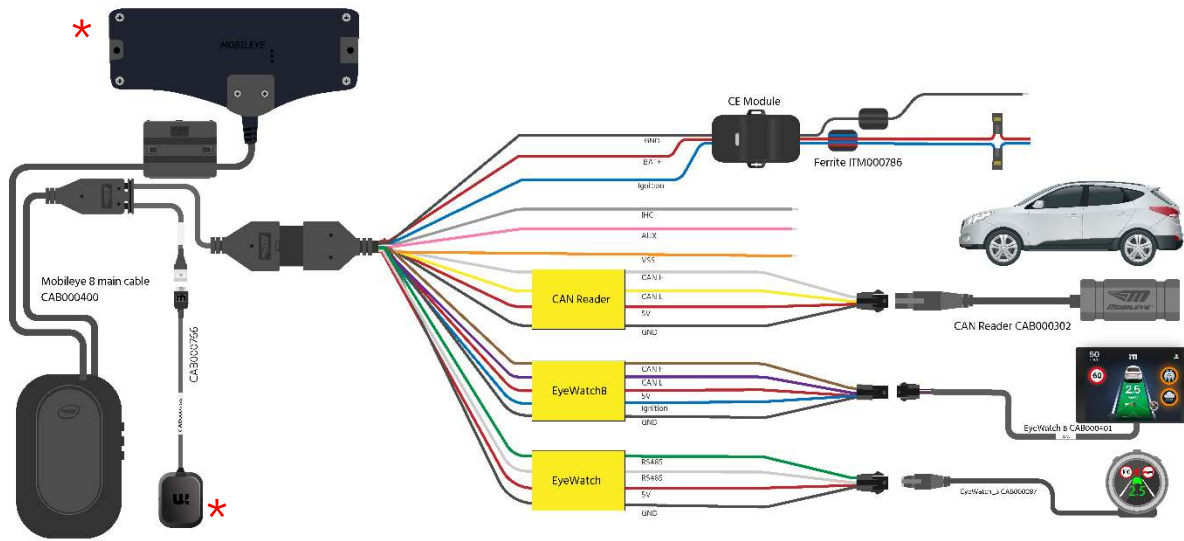

The CE module is required only in CE regulated territories.

* For Mobileye 8 Connect 4G

8. Installation & Calibration

8.1 Back-Cover removal

As part of the Mobileye 8 series calibration process, the camera angle must be adjusted as outlined below.

To access the camera angle adjustment `s screw you must remove the main unit`s back cover.

To remove the back cover:

1. Using a small flat screwdriver, slide and push out the oval cover.



2. Using a small Philips screwdriver, unscrew the 3 screws and remove the main back cover

3.

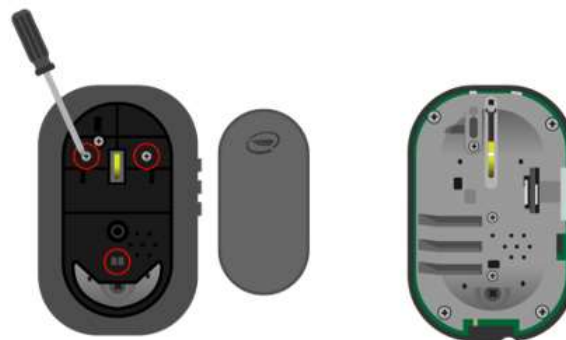

8.2 Communication / Connection phase

Mobileye 8 series service port interface is used to communicate with the Mobileye system.

The EyeNET adapter enables fast connection between the Mobileye 8 series and Mobileye software running on a computer for system calibration and configuration.

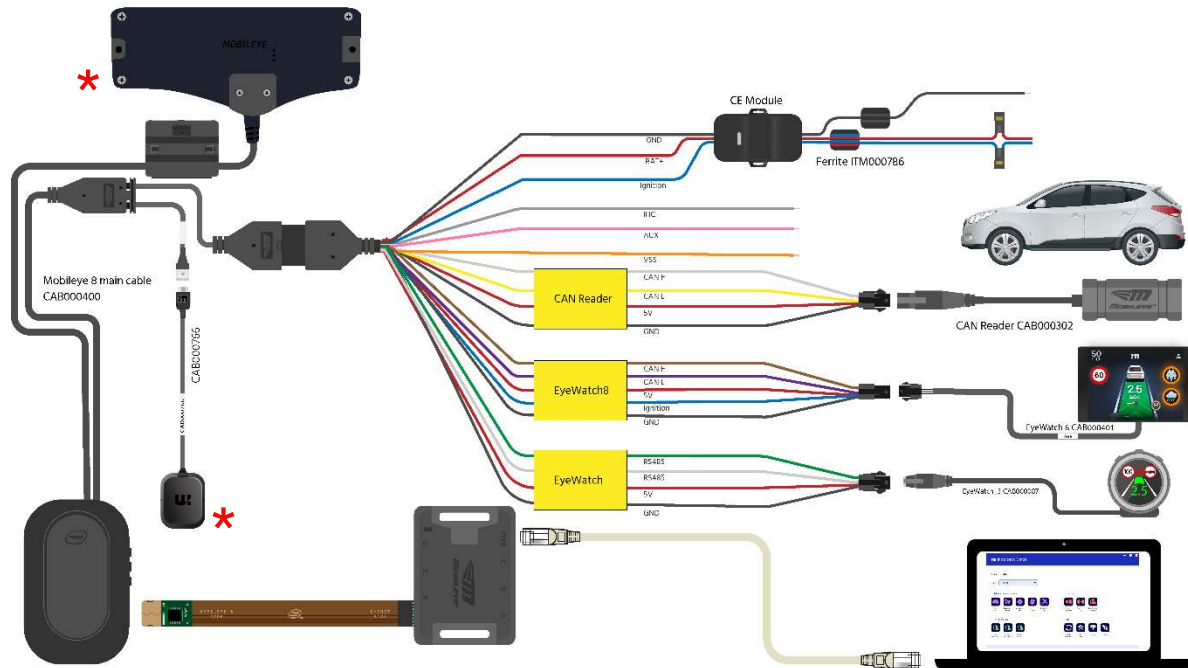

Figure 1 – connection method with EyeNET adapter

** For Mobileye 8 Connect 4G

Warning

- EyeNET connection to the Mobileye 8 series unit should only be performed when system power is off!
- Make sure you connect the short flex cable (BRD000350) correctly:
 - ❖ One side to the Mobileye 8 unit labeled as "MOBILEYE8 SIDE."
 - ❖ The other side to the EyeNET Box (BRD000344) labeled as "EYENET SIDE."

Note

Internet access is mandatory to configure and calibrate Mobileye 8 series.

8.3 System Calibration

8.3.1 Login

Open the Installation Center application on your computer and login using your personal login details.

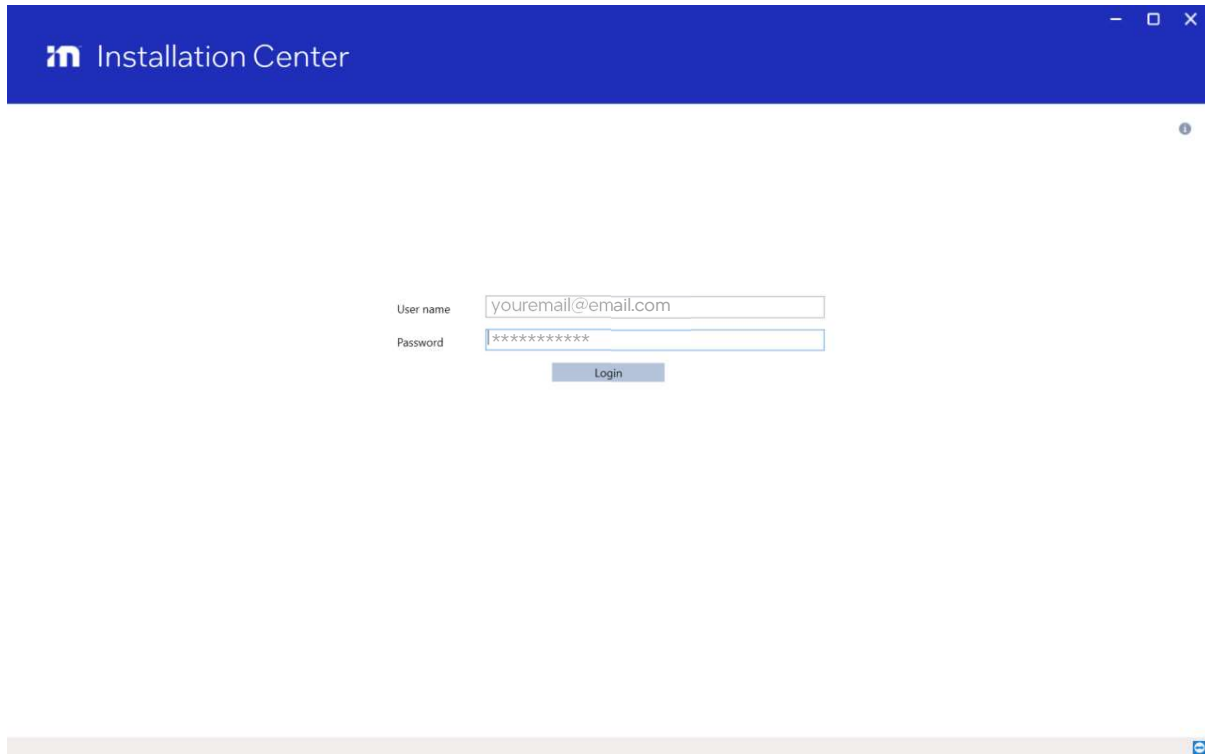

→ Click "Login" to continue.

8.3.2 Login

Choose your installation site from the dropdown list.

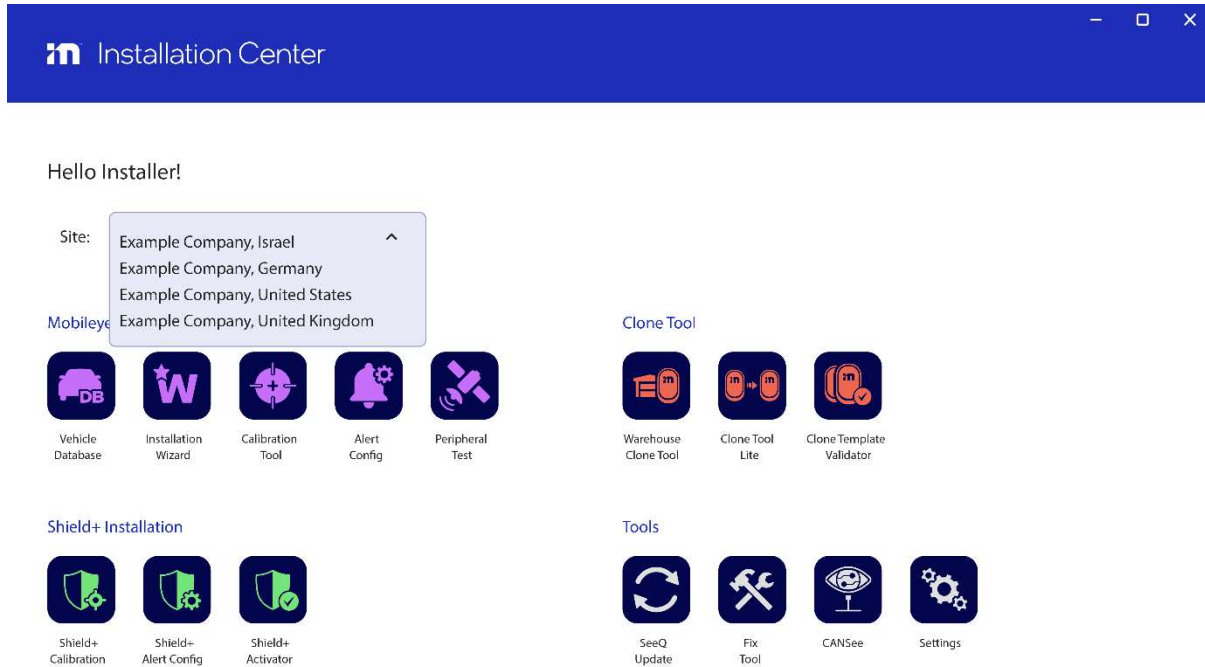

Click the vehicle database icon  to open the Mobileye vehicle database and browse to find the correct profile of the vehicle you are installing.

In the vehicle database, you can find the following information:

- ❖ Vehicle make/year/model.
- ❖ CAN-bus signals availability
- ❖ CAN-bus wires location + picture

CAN-bus baud rate

Note

- When clicking the "vehicle database" button, no physical connection is required.
- It is possible to continue and open the IC Wizard application directly from the vehicle database.
- If you are already connected to a Mobileye 8 series system and have completed the physical connections, you may skip the "vehicle database" and click the "wizard" button to immediately start the installation.

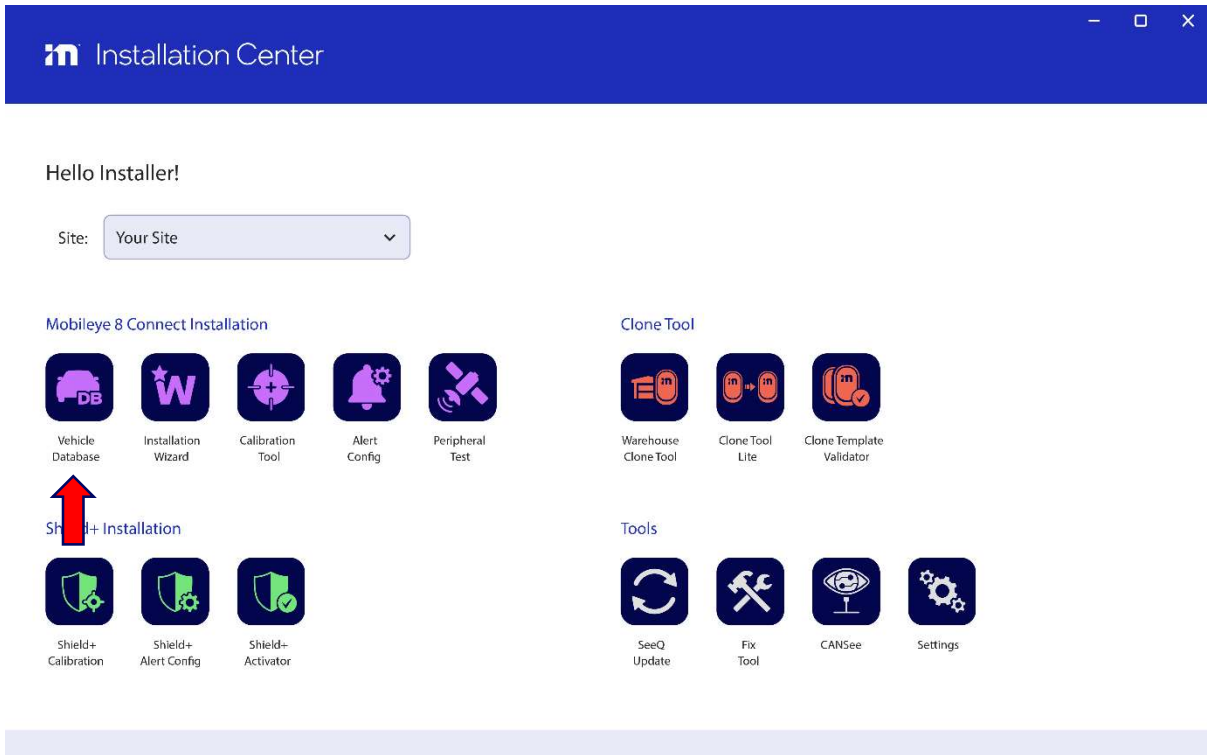

Note

When clicking the "Wizard" button you must be physically connected to a Mobileye 8 series system and the system power must be on to continue the calibration process. You will have an option to browse and choose the correct profile of the vehicle you are installing during a standard Wizard run as well.

8.3.3 Vehicle Selection

Choose the correct vehicle profile from the vehicle database.

The Mobileye vehicle database contain CAN information such as: available signals, CAN-bus wires location, bus speed, CAN-bus wires colors or pin number if available and pictures of the vehicle & CAN wires location.

Note

In the event the vehicle into which you are installing is not in the vehicle database, you can either try a similar profile or contact Mobileye support for help with creating a new profile.

→ Click "Go to App" to continue.

8.3.4 Connection to SeeQ

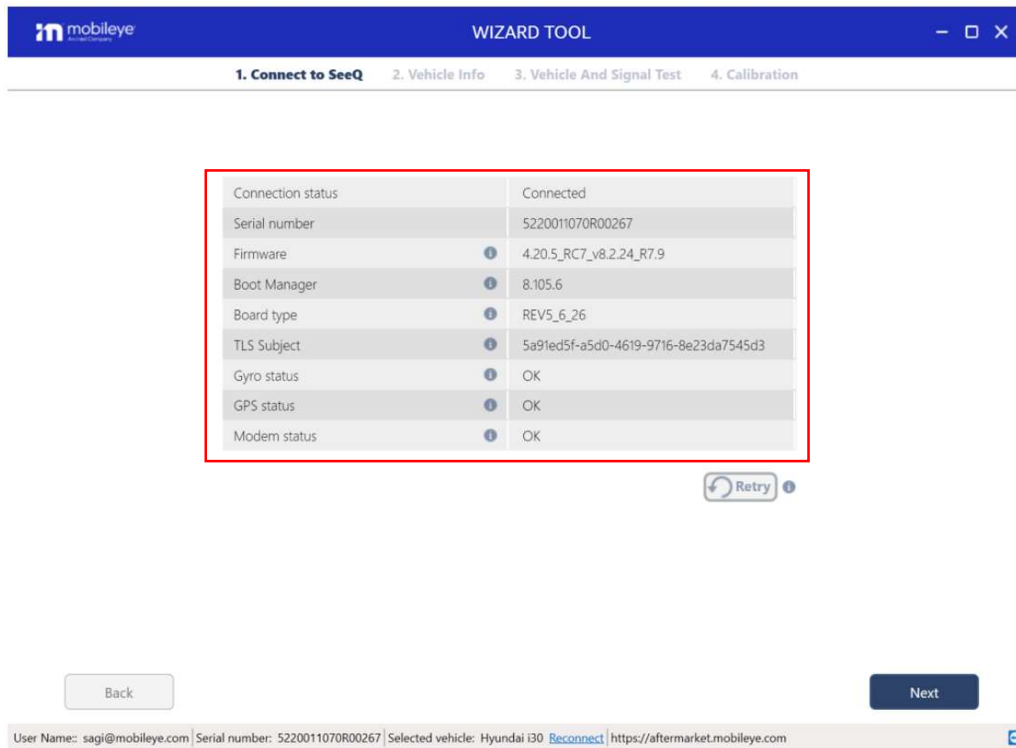

The app will check:

communication status with Mobileye’s system and provide system information such as:

- ❖ Connection status
- ❖ System serial number
- ❖ System firmware version
- Physical connection and communication of the below peripherals with the app*
 - ❖ Gyro
 - ❖ GPS
 - ❖ GSM

Note

If you click the "retry" button, the app will try to reestablish communication and display the system information if successful.

- ❖ → Click "Next" to continue.

* Peripherals check is skipped on some Mobileye 8 Series models (NC and SA)

8.3.5 Vehicle Information

The software will remember and display all the vehicle and profile information you chose earlier. You can always choose a new profile or modify your earlier selection at this time.

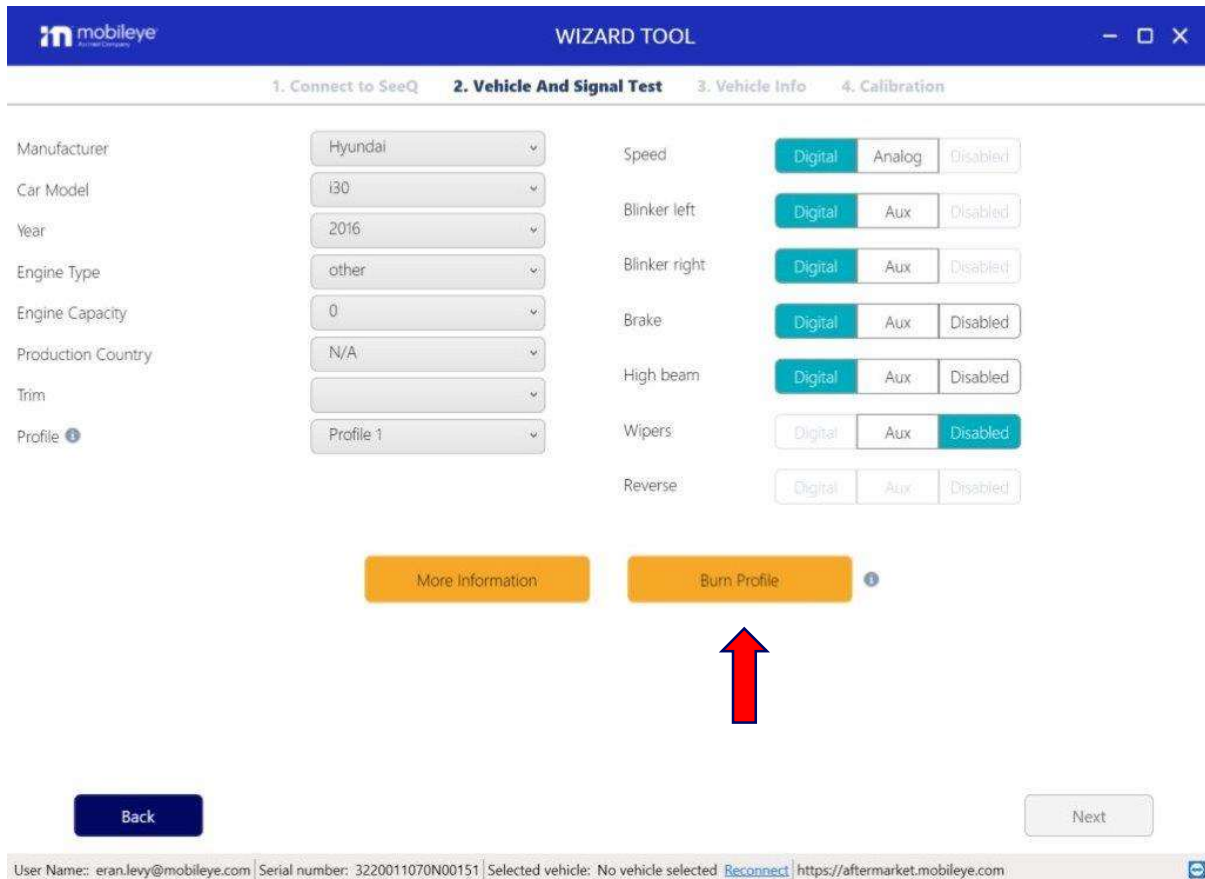

Click → **"Burn selected profile"** to burn and save the profile data into the Mobileye system.

Note

- You can change and burn different profiles until finding the correct profile.
- You cannot proceed with system calibration until you pass the signals test.

8.3.7 Analog Installation

In a case you install the unit in vehicle which speed is not available by CAN, please locate the VSS signal in the vehicle, choose the most similar vehicle profile from the vehicle DB and change the Speed input from "Digital" to "Analog", VSS rate field will be available to be filled according the specific VSS of the relevant vehicle.

If you don't know the vehicle VSS rate, set the value to 5000, Burn the profile as set and check the Vehicle speed vs the Mobileye Installation Center shown speed, if necessary, please adjust the rate so the speed shown will be accurate.

The screenshot shows the 'WIZARD TOOL' interface with the following configuration:

Field	Value
Manufacturer	Hyundai
Car Model	i30
Year	2016
Engine Type	other
Engine Capacity	0
Production Country	N/A
Trim	
Profile	Profile 1
Speed	Analog (5000)
Blinker left	Digital
Blinker right	Digital
Brake	Digital
High beam	Digital
Wipers	Disabled
Reverse	Digital

Buttons: More Information, Burn Profile

Navigation: Back, Next

8.3.8 Signal Test

Verify that all signals are detected by the Mobileye system.

Activate each signal and an icon will be shown when it is detected by the Mobileye system.

Speed signal verification - drive and confirm speed indication in the Mobileye setup wizard approximately matches the speed of the car shown by the speedometer.

Note

- Signals activations are possible only after the speed signal is verified and marked as
- To proceed to the next step, the full signals test must be successfully completed.



→ Click "Next" to continue.

8.3.8.1 Signal Test Troubleshooting

If the signals test failed in all or some of the inputs, please follow the next steps and press "reset test"

- Before any signal test activation, wait until the speed signal green V icon will be shown and only then test the other signals activation.
- Check your connections- make sure the CAN sensor is connected correctly.
- Try to switch CAN High and CAN Low connections- try to flip the CAN Sensor on the CAN wires and reset test again.
- Make sure you connected to the CAN wires as described in the Mobileye Vehicle Database.
- Check the chosen profile- make sure you chose the correct profile, if needed try to choose other similar profile, burn it and check the signals test again.

→ Click "Next" to continue.

Vehicle Information

1. Select the vehicle category- the vehicle category can be found in the vehicle license documentation.

A full description of the vehicle categories and information are available at https://en.wikipedia.org/wiki/Vehicle_category

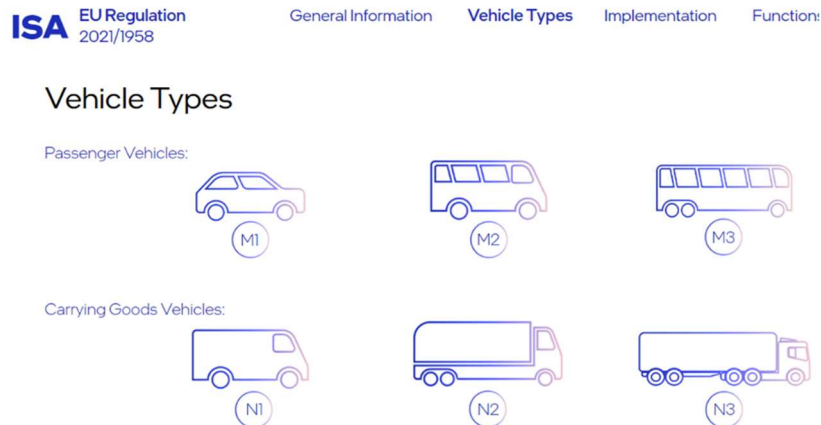

2. According to the vehicle Type selection, you may require choosing additional information such as Vehicle Class and select whether the vehicle is articulated or not.
 - 2.1 Vehicle class and articulated will be required only for some categories (for example: M3)
3. If the vehicle has a built-in speed limitation- drag the slide bar to the speed limitation value.
4. Choose the driving country.
5. Insert the vehicle weight (registered vehicle weight as indicated in vehicle registration document)

→ Click "Next" to continue.

8.3.9 Calibration

8.3.9.1 Step 1 – TAC assembly

Place the TAC target in front of & exactly at the center of the vehicle.

When TAC is assembled and open correctly the bottom part of the checkered board TAC should be 90 cm from ground or 165 cm if the TAC is opened and flipped to high level (depending on the camera height).

Mount the camera on the windshield according to Mobileye’s guidelines as follows:

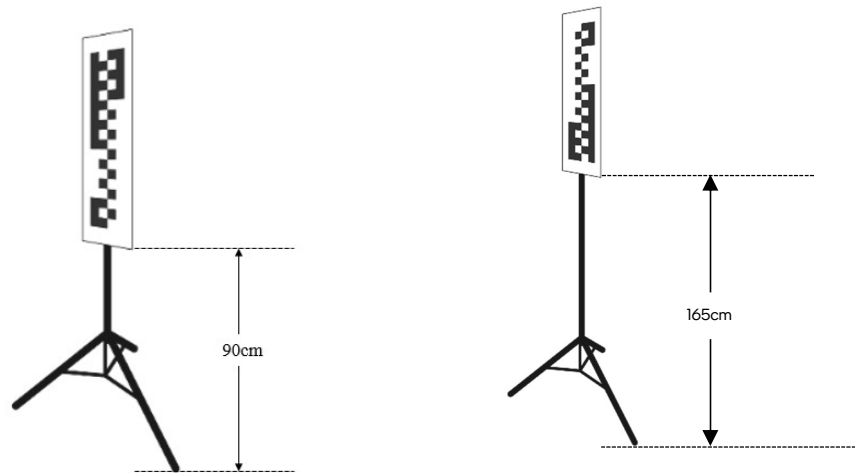

8.3.9.2 Step 2 – Camera attachment

Use the surface cleaner supplied in the kit to clean the attachment area of the windshield and then use a dry paper towel to dry the area and remove residue before attaching the camera.

Mount the camera using the live image feed from the camera unit, showing the grid lines over the TAC target. This image feed will assist you in mounting the camera correctly and within the allowed camera tilt/roll of up to 2°. Use the grid to properly attach the camera with as little tilt/roll as possible.

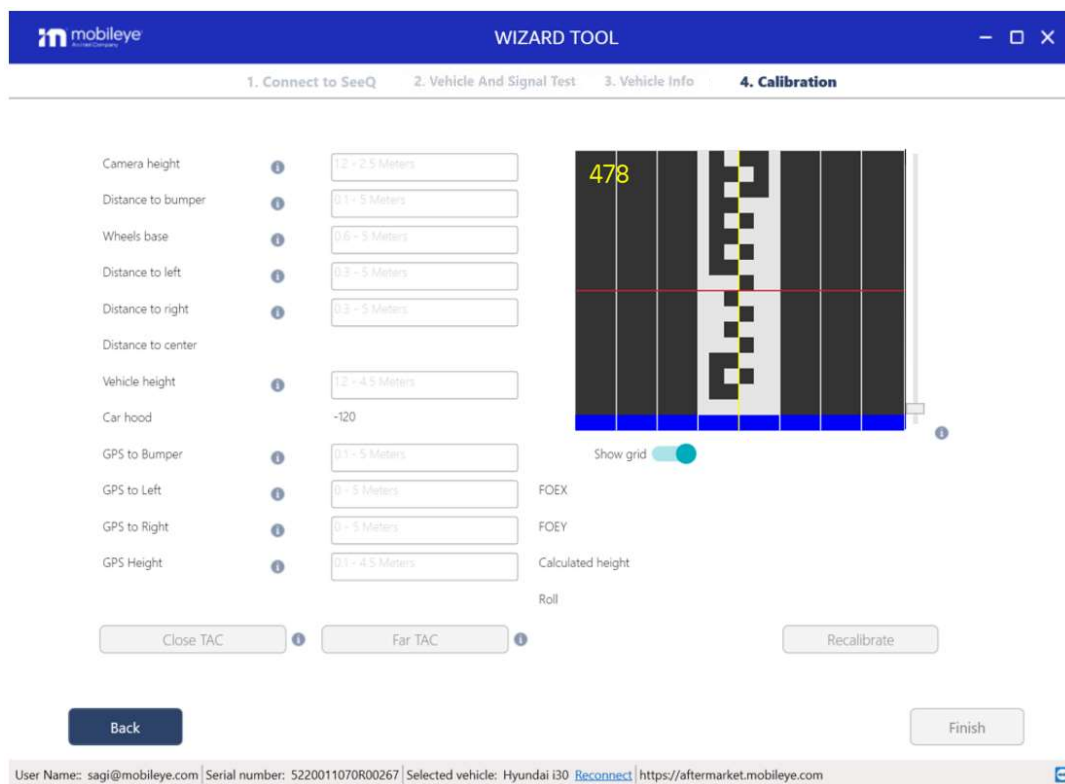

Attach the main camera unit; lining up the IC Wizard **Yellow** line exactly with the camera location on the TAC.

For example:

If the camera is mounted exactly in the center of the windshield, the yellow line should be in the center of the TAC target.

If the camera is mounted off-center, make sure this offset is reflected in the yellow line location on the TAC target.

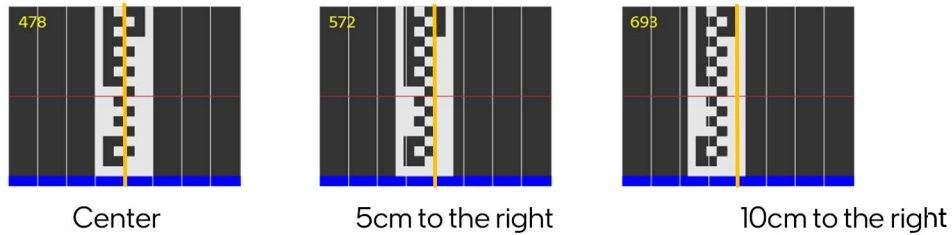

Deviation Offset

Optimal- center of the windshield, if center not possible, according to the vehicle width:

- a. If the vehicle width measurement is **up to** 1.67 meters- camera can be attached up to 10cm from the windshield center **MAX**.
- b. If the vehicle width measurement is **more** than 1.67 meters- camera can be attached up to 8% of the vehicle width measurement.

Vehicle width in cm X 0.08 = MAX OFFSET

9. GPS attachment

9.1 Step 3 – GPS attachment

GPS module is used for Mobileye 8 Series models 4G and SA.

Use the surface cleaner supplied in the kit to clean the attachment area of the windshield and then use a dry paper towel to dry the area and remove residue before attaching the GPS attachment.

Attach the GPS module mount using the 3M double-sided tape.

Make sure the GPS is facing up and attached in cleared area on the windshield.

The Mobileye GPS module can be attached at one of vehicle windshield corners in area **not** covered by the wipers and/or without any other Metal obstructions.

As the driver dashboard encapsulates various systems that may create disturbances,

Note

- GPS module can't be attached more than 0.49m ahead from the camera unit. (Camera distance to bumper – GPS distance to bumper < 0.49m)
- Validation tests were performed on several vehicle models. In some models the GPS may not be fully functional in the Top/Bottom left corners of the windshield due to interferences from other vehicle components and a different location may be required. We recommend each installation is completed by a run of the Peripheral Tool to verify full components functionality.

Mobileye recommends to install the GPS module at one of the 4 windshield corners (refer to the drawing).

9.2 GPS attachment location allowed areas.

Angled Windshield:

Green – GPS attachment location allowed

Red – GPS attachment location not allowed



Flat Windshield:

Green – GPS attachment location allowed

Red – GPS attachment location not allowed



*For Mobileye 8 Series 4G and SA models

10. Step 4 – Measurements

⚠ Caution

Entering any measurement that is not in the acceptable range or not in the correct format will be highlighted in red and will not let you continue to the next step.

Enter each vehicle measurement in the correct field:

WIZARD TOOL

1. Connect to SeeQ 2. Vehicle And Signal Test 3. Vehicle Info 4. Calibration

Camera height	1.2 - 2.5 Meters
Distance to bumper	0.1 - 5 Meters
Wheels base	0.6 - 5 Meters
Distance to left	0.3 - 5 Meters
Distance to right	0.3 - 5 Meters
Distance to center	
Vehicle height	1.2 - 4.5 Meters
Car hood	-120
GPS to Bumper	0.1 - 5 Meters
GPS to Left	0 - 5 Meters
GPS to Right	0 - 5 Meters
GPS Height	0.1 - 4.5 Meters

FOEX
FOEY
Calculated height
Roll

Close TAC Far TAC Recalibrate

Back Finish

User Name: sagi@mobileye.com | Serial number: 5220011070R00267 | Selected vehicle: Hyundai i30 Reconnect | https://aftermarket.mobileye.com

❖ Camera height

Measure the camera height from the camera lens to the ground.



Camera height	1.2 - 2.5 Meters
Distance to bumper	0.1 - 5 Meters
Wheels base	0.6 - 5 Meters
Distance to left	0.3 - 5 Meters
Distance to right	0.3 - 5 Meters
Distance to center	
Vehicle height	1.2 - 4.5 Meters
Car hood	-120
GPS to Bumper	0.1 - 5 Meters
GPS to Left	0 - 5 Meters
GPS to Right	0 - 5 Meters
GPS Height	0.1 - 4.5 Meters



❖ **Distance to bumper** (the distance from the camera to the front bumper).

Measure the horizontal distance from the camera lens to the vehicle's front bumper edge.

Camera height	1	1.2 - 2.5 Meters
Distance to bumper	1	0.1 - 5 Meters
Wheels base	1	0.6 - 5 Meters
Distance to left	1	0.3 - 5 Meters
Distance to right	1	0.3 - 5 Meters
Distance to center		
Vehicle height	1	1.2 - 4.5 Meters
Car hood		-120
GPS to Bumper	1	0.1 - 5 Meters
GPS to Left	1	0 - 5 Meters
GPS to Right	1	0 - 5 Meters
GPS Height	1	0.1 - 4.5 Meters

For vehicles without front engine hood, Measure and enter the true distance from camera to front bumper.

❖ **Wheels Base** (width of the vehicle wheels)

Measure the distance between the outer edges of the front wheels.

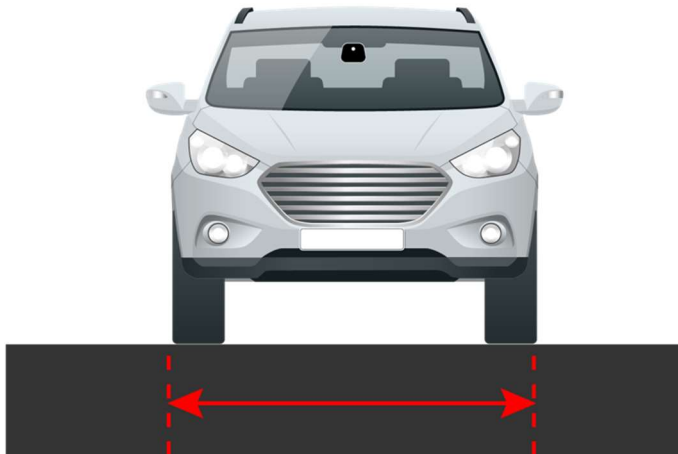

Camera height	<input type="text" value="1.2 - 2.5 Meters"/>
Distance to bumper	<input type="text" value="0.1 - 5 Meters"/>
Wheels base	<input type="text" value="0.5 - 2 Meters"/>
Distance to left	<input type="text" value="0.3 - 5 Meters"/>
Distance to right	<input type="text" value="0.3 - 5 Meters"/>
Distance to center	
Vehicle height	<input type="text" value="1.2 - 4.5 Meters"/>
Car hood	-120
GPS to Bumper	<input type="text" value="0.1 - 5 Meters"/>
GPS to Left	<input type="text" value="0 - 5 Meters"/>
GPS to Right	<input type="text" value="0 - 5 Meters"/>
GPS Height	<input type="text" value="0.1 - 4.5 Meters"/>

❖ **Distance to left, distance to right** (the camera distance from the left and right windshield edge).

Measure the lateral distance from the camera lens to both left & right windshield edges.

PLEASE NOTE: Left & Right should be measure from the outside of the vehicle but should be insert to the software as driver perspective sides (see Left & Right on the illustration bellow).

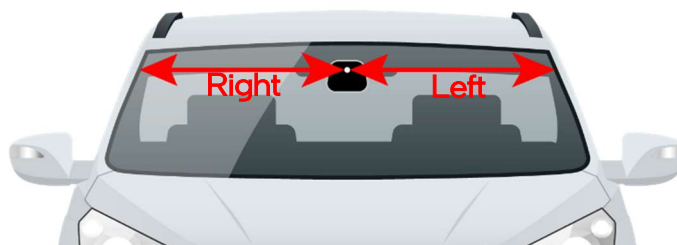

Camera height	<input type="text" value="1.2 - 2.5 Meters"/>
Distance to bumper	<input type="text" value="0.1 - 5 Meters"/>
Wheels base	<input type="text" value="0.5 - 2 Meters"/>
Distance to left	<input type="text" value="0.3 - 5 Meters"/>
Distance to right	<input type="text" value="0.3 - 5 Meters"/>
Distance to center	
Vehicle height	<input type="text" value="1.2 - 4.5 Meters"/>
Car hood	-120
GPS to Bumper	<input type="text" value="0.1 - 5 Meters"/>
GPS to Left	<input type="text" value="0 - 5 Meters"/>
GPS to Right	<input type="text" value="0 - 5 Meters"/>
GPS Height	<input type="text" value="0.1 - 4.5 Meters"/>

❖ **Vehicle Height**

Measure the distance from ground to the top of the vehicle.



Camera height	<input type="text" value="1.2 - 2.5 Meters"/>
Distance to bumper	<input type="text" value="0.1 - 5 Meters"/>
Wheels base	<input type="text" value="0.8 - 5 Meters"/>
Distance to left	<input type="text" value="0.3 - 5 Meters"/>
Distance to right	<input type="text" value="0.3 - 5 Meters"/>
Distance to center	<input type="text" value=""/>
Vehicle height	<input type="text" value="1.2 - 4.5 Meters"/>
Car hood	-120
GPS to Bumper	<input type="text" value="0.1 - 5 Meters"/>
GPS to Left	<input type="text" value="0 - 5 Meters"/>
GPS to Right	<input type="text" value="0 - 5 Meters"/>
GPS Height	<input type="text" value="0.1 - 4.5 Meters"/>

❖ **GPS Measurements (the GPS location) -**

In this section, measure the exact GPS location on the Windshield.

GPS to Bumper measurement:

Measure the horizontal distance from the GPS unit to the vehicle's front bumper edge (Distance to Bumper)



Camera height	<input type="text" value="1.2 - 2.5 Meters"/>
Distance to bumper	<input type="text" value="0.1 - 5 Meters"/>
Wheels base	<input type="text" value="0.8 - 5 Meters"/>
Distance to left	<input type="text" value="0.3 - 5 Meters"/>
Distance to right	<input type="text" value="0.3 - 5 Meters"/>
Distance to center	<input type="text" value=""/>
Vehicle height	<input type="text" value="1.2 - 4.5 Meters"/>
Car hood	-120
GPS to Bumper	<input type="text" value="0.1 - 5 Meters"/>
GPS to Left	<input type="text" value="0 - 5 Meters"/>
GPS to Right	<input type="text" value="0 - 5 Meters"/>
GPS Height	<input type="text" value="0.1 - 4.5 Meters"/>

Please Note: GPS module can't be attached more than 0.49m ahead from the camera unit. (Camera distance to bumper – GPS distance to bumper < 0.49m)

GPS to Left & Right Wheel measurement.

Measure the GPS unit distance from Left & Right windshield edge.

PLEASE NOTE: Left & Right should be measure from the outside of the vehicle but should be insert to the software as driver perspective sides (see Left & Right on the illustration bellow.

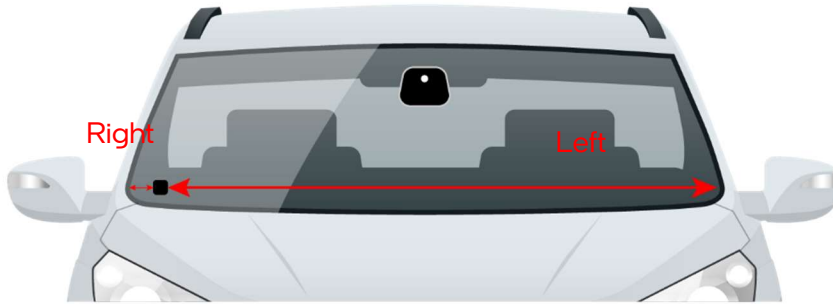

Camera height	1	1.2 - 2.5 Meters
Distance to bumper	1	0.1 - 5 Meters
Wheels base	1	0.6 - 5 Meters
Distance to left	1	0.3 - 5 Meters
Distance to right	1	0.3 - 5 Meters
Distance to center		
Vehicle height	1	1.2 - 4.5 Meters
Car hood		-120
GPS to Bumper	1	0.1 - 5 Meters
GPS to Left	1	0.1 - 5 Meters
GPS to Right	1	0.1 - 5 Meters
GPS Height	1	0.1 - 4.5 Meters

GPS Height measurement-

Measure the exact GPS height from to ground.



Camera height	1	1.2 - 2.5 Meters
Distance to bumper	1	0.1 - 5 Meters
Wheels base	1	0.6 - 5 Meters
Distance to left	1	0.3 - 5 Meters
Distance to right	1	0.3 - 5 Meters
Distance to center		
Vehicle height	1	1.2 - 4.5 Meters
Car hood		-120
GPS to Bumper	1	0.1 - 5 Meters
GPS to Left	1	0.1 - 5 Meters
GPS to Right	1	0.1 - 5 Meters
GPS Height	1	0.1 - 4.5 Meters

(i) Note

- GPS measurements are required only for Mobileye 8 Series 4G and SA models. GPS measurements input is not required and will not be available for NC models.

11. Step 5 – Camera angle adjustment

After measuring the camera height and entering it into the Wizard, mark the camera height on the TAC board using a black tape and manually adjust the camera's lens so that the RED line will be parallel to the height mark on the TAC.

Once the red line in the image is lined up with the marking you placed on the TAC, tighten the camera angle adjustment screw.

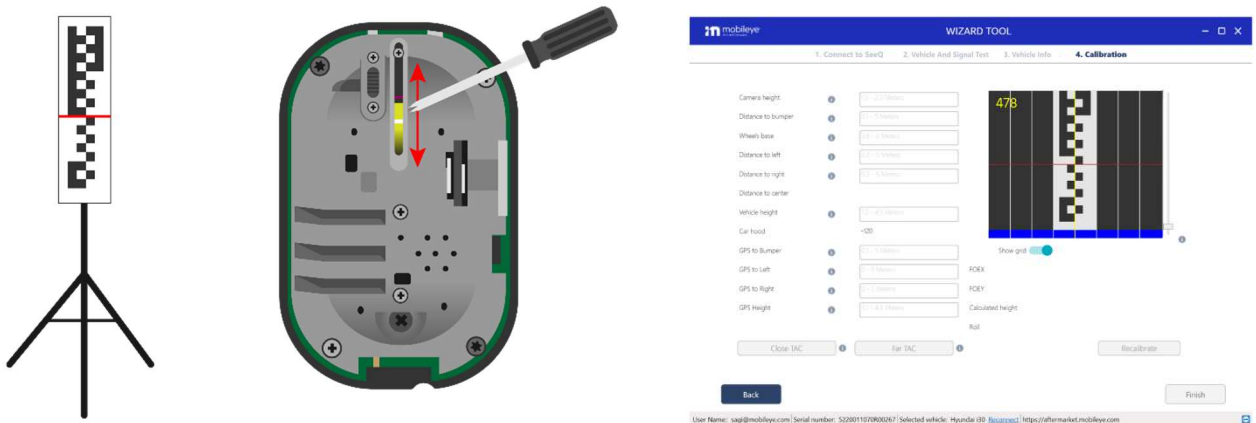

11.1 Step 6 – Car hood

Drag the scroll bar on the left side of the image to adjust the blue field and prevent the camera from 'seeing' the hood of the vehicle.

See image below:

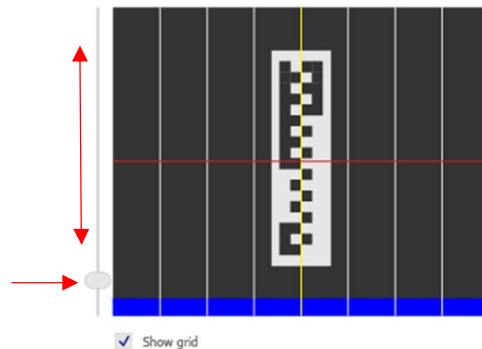

Caution

Perform vehicle hood calibration only if the hood poses a permanent obstruction to the camera's field of view.

If no car engine hood is present in the image, car hood value should remain at the default value of -120

11.2 Step 7 – Calibration

Once all these measurements have been entered, 2 calibration steps are required:

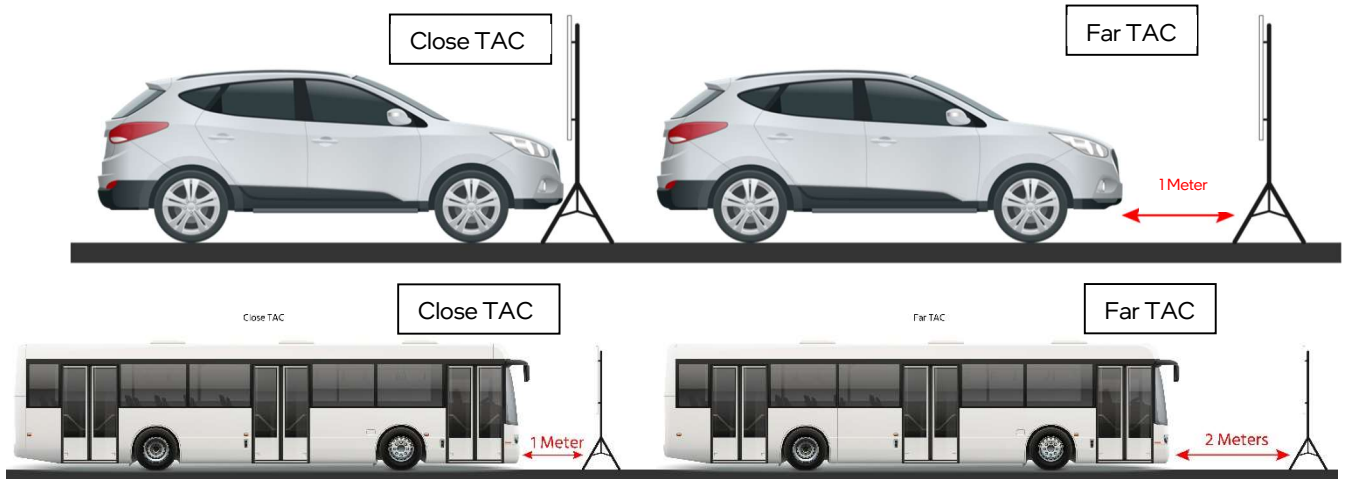

Close TAC

Place the TAC exactly in the center of the vehicle and close to the vehicle bumper.

Press "Close TAC" for close TAC calculation.

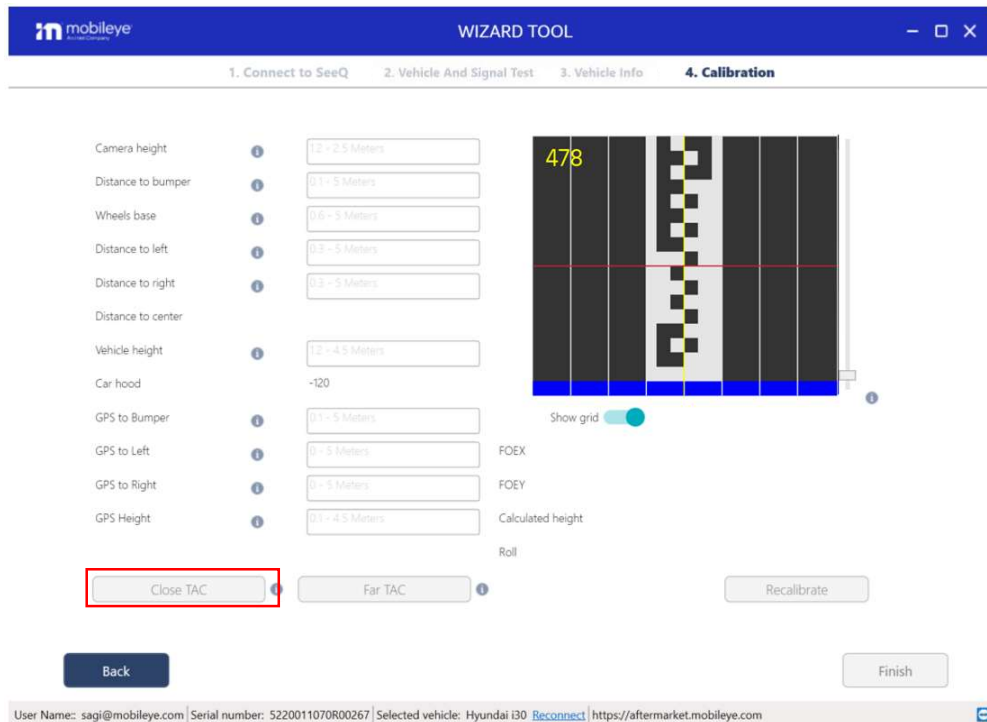

Far TAC

After the close TAC calculation has been successfully completed, a pop-message will appear.

Move the TAC 1-meter back Press "OK" and.

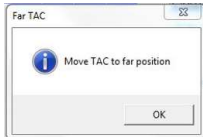

Press "Far TAC" for far TAC calculation.

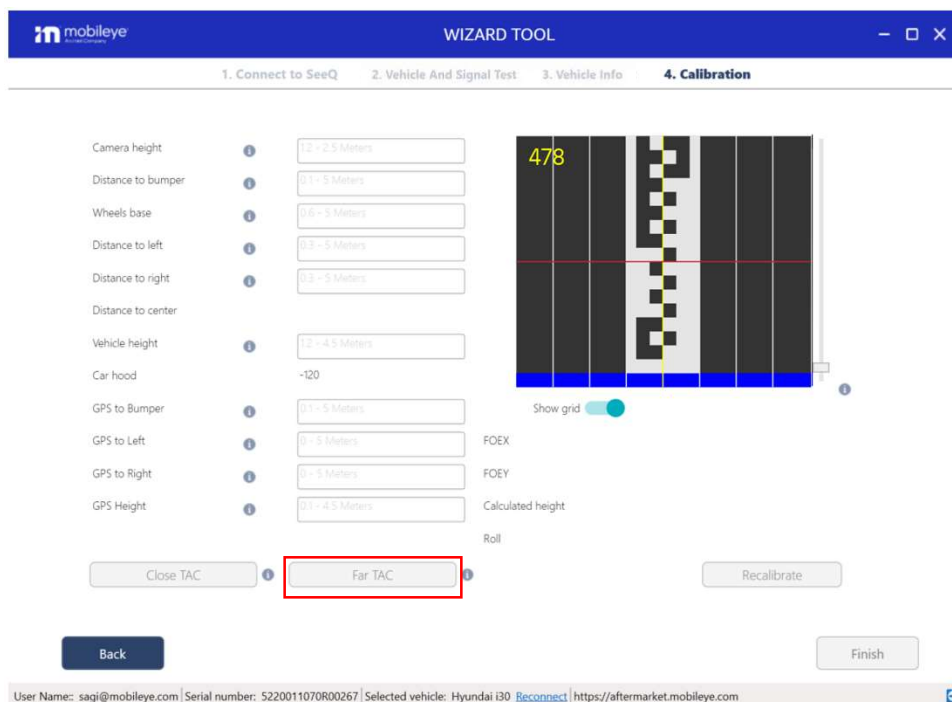

Step 9 – calibration results

Once the calibration calculation will be completed, the calibration results will be shown on the bottom-Right side of the Calibration slide:

The

Calibration results should meet the following requirements:

1. FOE X optimal value is 0 (± 15)
2. FOE Y optimal value according to the following table (± 10)

FOE Y OPTIMAL VALUES	
Camera Height (meters)	Expected FOE Y value (± 10)
1.20 – 1.80	0
1.85	27
1.90	28
2.00	30
2.10	32
2.20 – 2.65	40

3. Calculated height- up to 3cm differences
4. Roll – up to 2°

If calibration results meet the minimum requirements mentioned above, calibration is completed, click "Finish."

12. Validation

10.1 General

Upon completion of the system calibration, the installer MUST validate all peripherals are functional and valid using the new validation tool which can be found as part of Mobileye IC prior to releasing the vehicle after the installation.

10.2 Operation

Click the icon to open the Peripherals tool.

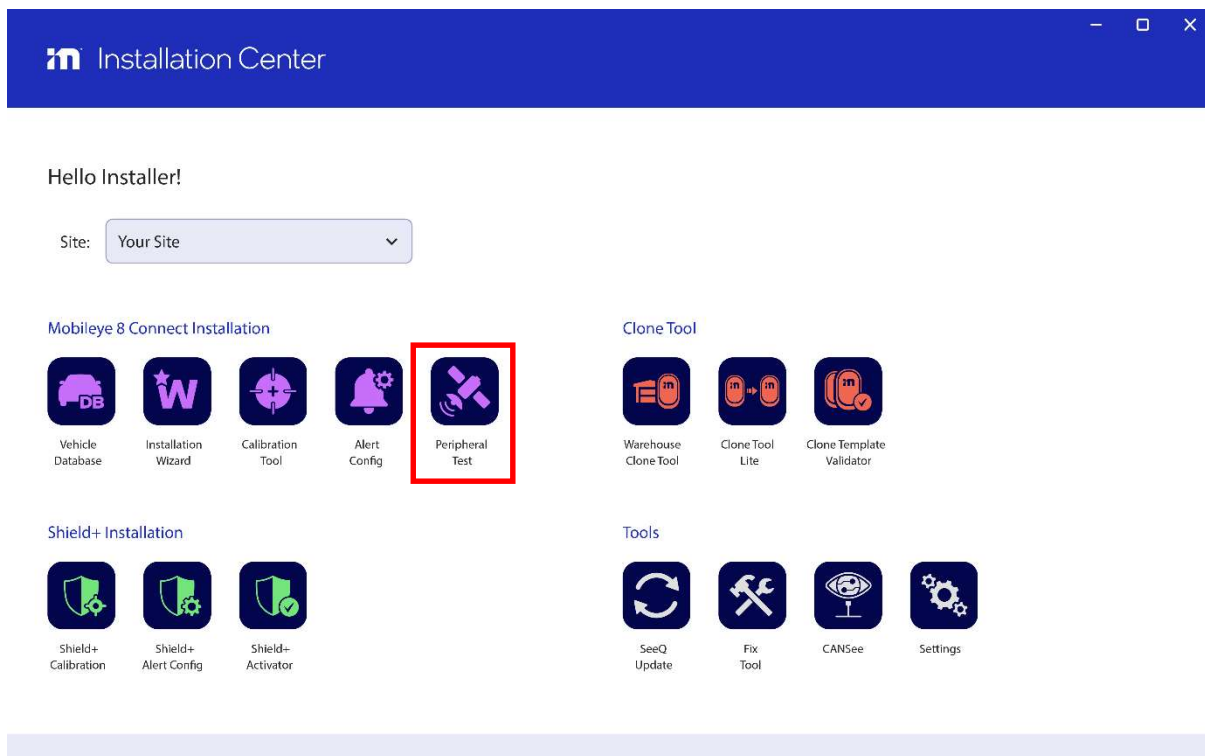

The tool will check communication with the system and display the system s/n and FW version following by the peripherals test and display the status of each component.

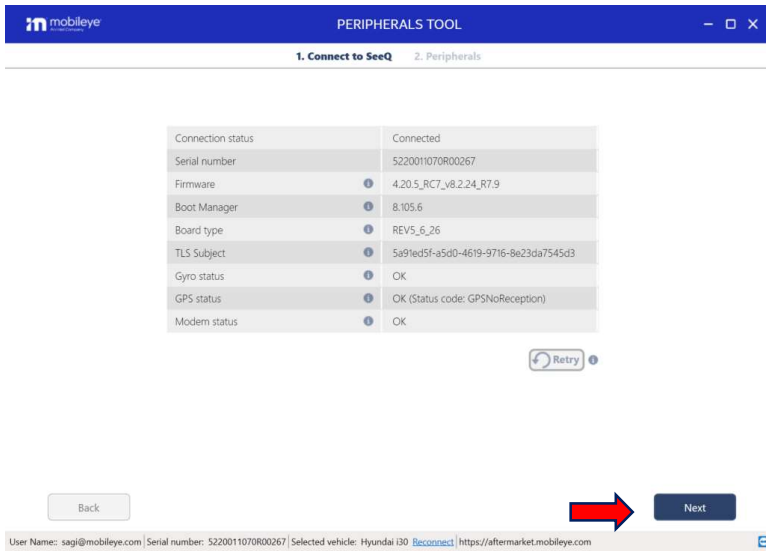

Click "Next" to continue to see each peripheral test results.

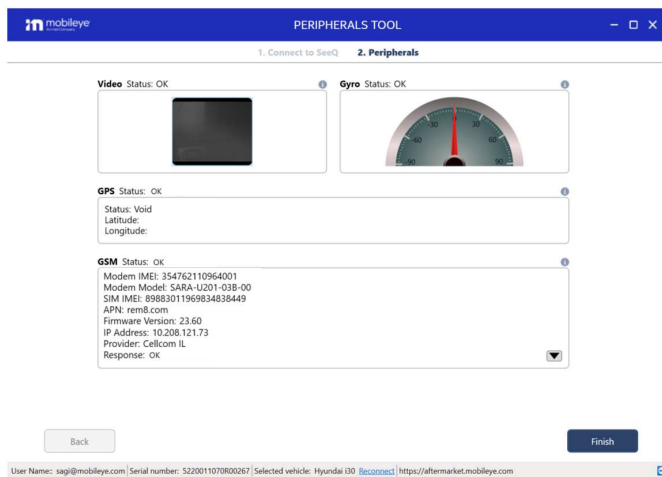

Note that due to the installation location such as underground parking or indoor garage and GPS signal or cellular network is not available, the test status of the relevant component will pass but no valid data will be displayed.

Caution

If any of the peripherals found faulty, the Mobileye system must be replaced to complete the installation.

13. Appendix A – 4G Modem

13.1 Modem Status



4G MODEM LED BEHAVIOR

LED	Status
CONSTANT GREEN	SW ready.
CONSTANT ORANGE	No SIM and/or no network
FLASHING ORANGE	Network and communication OK

13.2 Technical Spec

4G Cellular Module	
PHYSICAL CHARACTERISTICS	
Model	Telit LE910C1
Length	182mm
Width	55mm (slimmest); 78.6mm in connector area (peak)
Height	22MM
Weight	Modem unit: 121.9g Modem cable: 119.3g
Color	Black
Case material	PC/ABS
Cable length	3000mm (±30)
Cable diameter	6.5mm
SPECIFICATION	
Protocols	LTE FDD Cat1 (10/5Mbps DL/UL), GSM/GPRS/EDGE, WCDMA up to DC
Coverage area	Global with several models LE910C1-xx
Bands	2G: 2, 3, 5, 8 HSPA+: 1, 2, 3, 4, 5, 6, 8, 19 LTE FDD: 1, 2, 3, 4, 5, 8, 12, 13, 14, 18, 19, 20, 25, 26, 28, 28A, 66, 71
Data rates	Up to 10Mbit/s DL Up to 5Mbit/s UL
Internet protocols version	IPv4 / IPv6
Transport layer security	SSL – several TLS
Certification	WW – depend on each model. FCC /IC, PTCRB, (North America) RCM (Australia) Jade/Telec (Japan) RED/GCF (Europe) CCC/SRCC (China) Anatel (Brazil)
Telecommunications standards	TS 27.005, 27.007 and Telit Custom AT commands LTE FDD Cat.4, 3GPP release 10 compliant. LTE FDD Cat.1. 3GPP release 9 compliant
Serial interface	UART (up to 3Mbps)
Power supply	12V
Sim voltage	1.8V
Sim size	Nano SIM 10mm X 12.5mm x 1.2mm

14. Appendix A – CAN Reader

14.1 General

The Mobileye 8 Connect CAN-Reader is a new, non-intrusive solution for CAN-bus connection.

No more wrong connections, warranty violations or liability issues. The Mobileye CAN-Reader will allow you to better handle a CAN-bus reading by simply placing the Mobileye CAN-sensor on the vehicle CAN-bus wires without any wire cutting or pinching.

Benefits:

- Non-intrusive installation
- Simply install over the CAN-bus wires, no need to cut, strip, crimp or connect physically.
- Read data thru the wire's isolation.
- Fits most vehicles.
- Supports all CAN-bus speeds.
- Reliable CAN-bus data reading

Fast and simple installation

14.2 CAN Reader installation (CAB000302)

1. Identify the vehicle CAN-bus wires.



2. Untwist the CAN-bus wires over about 5cm.



3. Place the CAN Reader over the CAN-bus wires as labeled on the CAN Sensor module.



Note: In some cases (if Er-20 shows on the EyeWatch display), you will need to switch between CAN High and CAN Low wires

15. Appendix B – up/down configuration

15.1 General

Mobileye 8 Connect is based on a smart camera, which is installed on the vehicle's front windshield. To suit all vehicle models (cars, trucks, buses) the smart camera main cable (CAB000400) has two configurations: up and down.

[Camera up position](#)

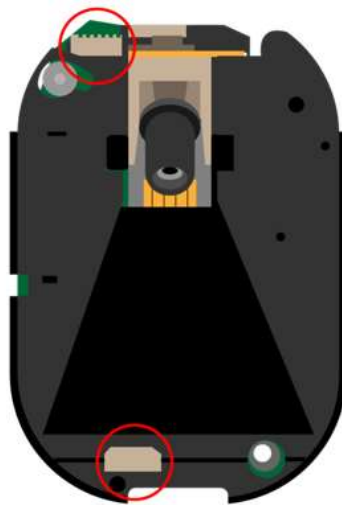

[Camera down position](#)

All Mobileye 8 Connect systems are supplied with a default up configuration. The distributor/installer can change the up/down configuration at their discretion.

Changing the Mobileye 8 Connect up/down configuration is a simple but delicate procedure.

Required Tools:

- ✓ Philips Screwdriver (Tip Size = PH1)
- ✓ Flat Screwdriver (Tip Size = PH1)

The Mobileye 8 with 4G modem has 2 types of chassis.

The difference of the camera chassis is the tunnel for the 4G modem cable.

With the new chassis, an additional tunnel is added at the bottom of the chassis – see image below:

Old chassis – MEC000956



New chassis – MEC000116



A camera with the new 4G chassis includes silicone cover plug (MEC0001117) to avoid dust and to be used in a case the 4G Modem cable (CAB000405) is routed from the bottom side.

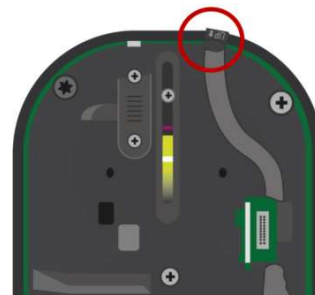

15.2 Up/down configuration – old chassis MEC000956

Using a flat screwdriver, slide and push out the ellipse cover.



Using a Philips screwdriver, unscrew the 3 screws and remove the main back cover.



Using a Philips screwdriver, unscrew to remove the main chassis from the frame.



Warning: Do not unscrew the upper left and lower right screws as it will void warranty!

Gently remove the chassis from the frame

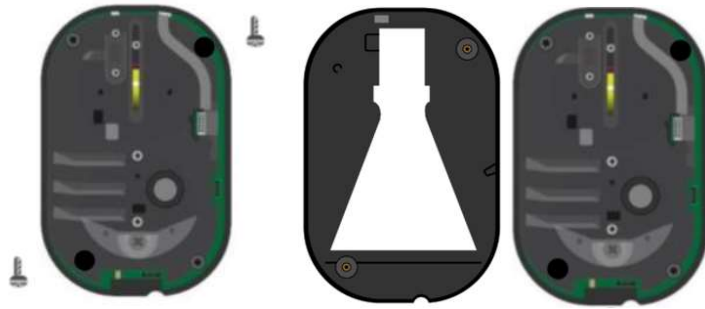

Remove the main cable connector and connect it to the desired configuration.

Note: with this hardware, the modem cable can be routed only from the top.



Once completed, reassemble all system components tightening the screws.

15.3 Up/down configuration – new chassis MEC000116

Using a flat screwdriver, slide and push out the ellipse cover.



Using a Philips screwdriver, unscrew the 3 screws and remove the main back cover.



Using a Philips screwdriver, unscrew to remove the main chassis from the frame.



Warning: Do not unscrew the upper left and lower right screws as it will void warranty!

Gently remove the chassis from the frame

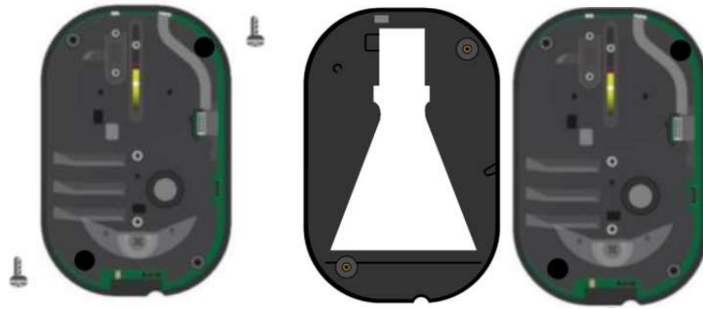

Remove the main cable connector and connect it to the desired configuration.

Routh the modem cable from the designated bottom tunnel



Once completed, reassemble all system components tightening the screws.

16. Appendix C – EyeNET Holder (ASY000451)

16.1 Introduction

The EyeNET holder used to hold the EyeNET and maintain a stable communication with the Mobileye system.

16.2 Component Overview

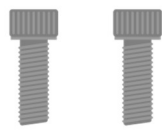

SCR000120

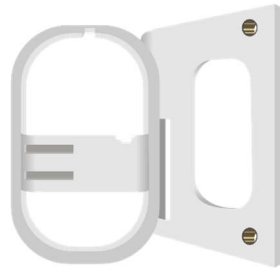

MEC000950

16.3 Assembly

Attach the EyeNET holder on top of the system's metal body.

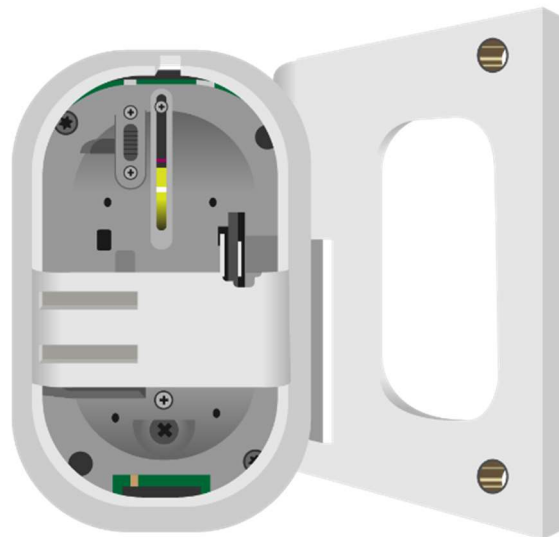

Use to 2x screws to hold the EyeNET

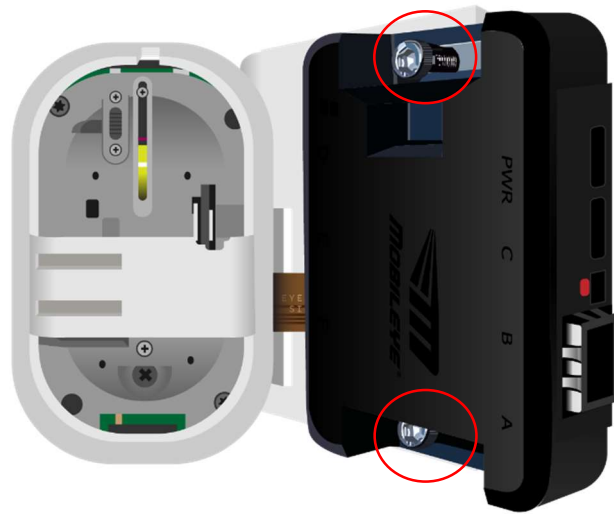

Route the EyeNET flat cable through the designated gap and connect it in both ends to the Mobileye system and the EyeNET and continue with the calibration process

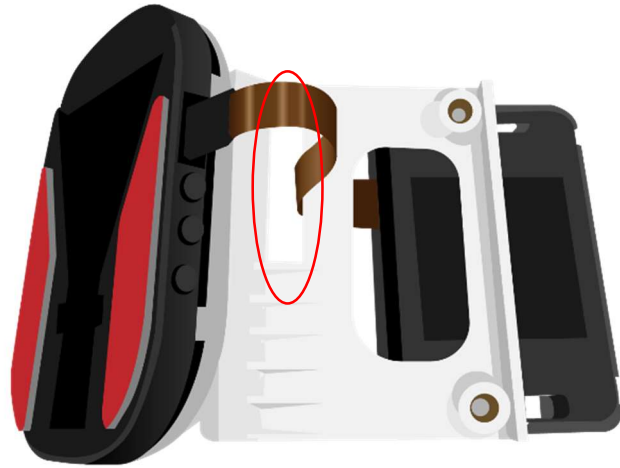

17. Appendix D – Calibration Tool

17.1 Intro

The Calibration Tool allows to recalibrate the ME8 units without deactivation vehicle profile change such as windshield replacement.

17.2 Instructions

1. To use the Calibration Tool run the app from the Installation Center main screen.

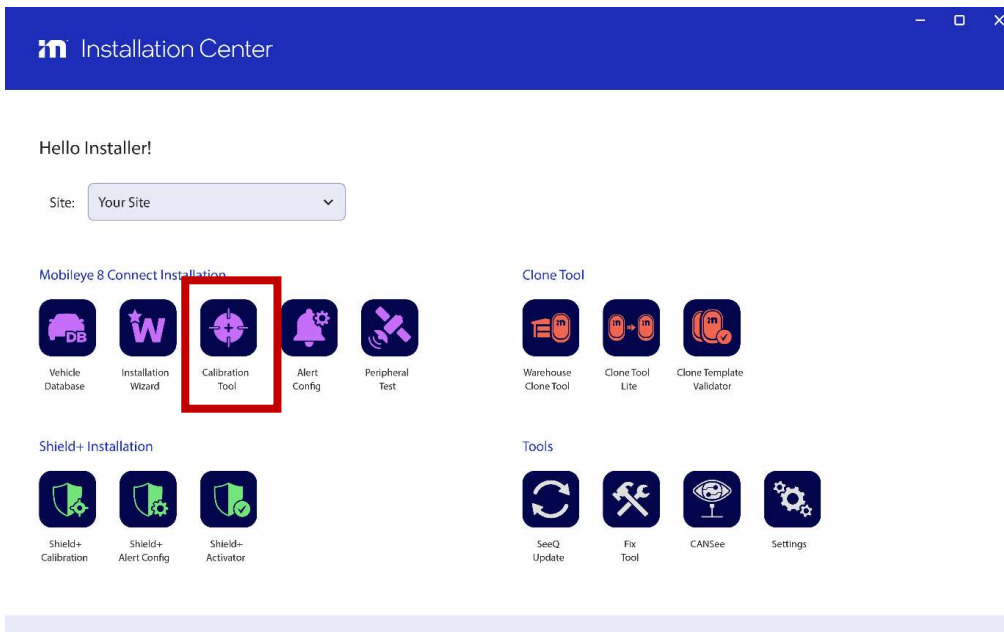

- The tool will check communication with the system and display the system s/n and FW version and display the status of each component.

The screenshot shows the 'CALIBRATION TOOL' window with the following data:

Connection status	Connected
Serial number	5220011070R00267
Firmware	4.20.5_RC7_v8.2.24_R7.9
Boot Manager	8.105.6
Board type	REV5_6_26
TLS Subject	5a91ed5f-a5d0-4619-9716-8e23da7545d3
Gyro status	OK
GPS status	OK (Status code: GPSNoReception)
Modem status	OK

Buttons: Back, Next, Retry

Footer: User Name: sagi@mobileye.com | Serial number: Not connected | Selected vehicle: Hyundai i30 | https://aftermarket.mobileye.com

- The camera attachment, measurements and calibration slide will show. To attach, measure and calibrate, please refer to pages 32-42.

The screenshot shows the 'WIZARD TOOL' window with various calibration parameters and a camera view:

- Camera height: 1.2 - 2.5 Meters
- Distance to bumper: 0.1 - 5 Meters
- Wheels base: 0.6 - 5 Meters
- Distance to left: 0.3 - 5 Meters
- Distance to right: 0.3 - 5 Meters
- Distance to center: 0.3 - 5 Meters
- Vehicle height: 1.2 - 4.5 Meters
- Car hood: -120
- GPS to Bumper: 0.1 - 5 Meters
- GPS to Left: 0 - 5 Meters (FOEX)
- GPS to Right: 0 - 5 Meters (FOEY)
- GPS Height: 0.1 - 4.5 Meters
- Calculated height
- Roll

Buttons: Close TAC, Far TAC, Recalibrate, Back, Finish

Footer: User Name: sagi@mobileye.com | Serial number: 5220011070R00267 | Selected vehicle: Hyundai i30 | Reconnect | https://aftermarket.mobileye.com

18. Troubleshooting

1. Installer kit:

- Check the TAC assembly.
- Check the EyeNET adapter and make sure the connectors are not damaged.

2. Installation issues:

If signal test fails, check that:

- You connected the correct CAN wires as instructed in the Mobileye Vehicle DB.
- Make sure you selected the correct profile for the vehicle. If necessary, try to use another profile or proceed to CAN sniffing for a new profile creation.

You can also try to switch the CAN sensor position on the vehicle CAN wires (CAN H and CAN L).

3. Calibration and software issues:

Calibration issues can be related to the 4 parameters required.

- If FOE X is more than ± 15 , check the camera location on the windshield and the position of the yellow line.
- If FOE Y value is more than ± 10 , check the measured camera height, the TAC height and lens angle (red line).
- The calculated camera height difference between what you measured and entered to the system may be up to 3cm.
- If the roll value is more than 2° , make sure that the vehicle calibration surface is flat, and the main camera unit attachment is not rolled.
- If you're having issues with the Installation Center installation on your laptop, make sure your laptop meets the minimum requirements.
- Communication issues can be related to your laptop LAN Port settings. Make sure the LAN Port is set and adjust on your OS.
- If your laptop is not equipped with a LAN Port, use an Ethernet to USB adapter (not included).

19. Technical Specification

19.1 Mobileye® 8 Series™ – 4G | Technical Specification Sheet

Mobileye® 8 Series Main Unit	
PHYSICAL CHARACTERISTICS	
Length	120mm
Width (without lens)	78mm
Height	44mm
Weight	200g
Color	Black
Case material	Plastic & Aluminum
Cable length (cab000400)	3m
Cable diameter	5.8mm (±0.2)
ELECTRICAL CHARACTERISTICS	
Input voltage	10-36VDC
Input current max	12v > 700mA, 24v > 350mA
Max power	8.5w
AMBIENT TEMPERATURE (AS TESTED IN LAB WITH NO RADIATION EFFECT)	
Operation	-20°C to +60°C
Storage temperature	-30°C to +85°C
VISION SENSOR	
Vision sensor	OV10642 RCCC CMOS 1.3MP
Active array size	1280H * 1080V
Optical format	1/2.56"
Size	4.2µm x 4.2µm
Dynamic range	48° (horizontal)
Shutter type	Rolling shutter
Responsivity	4.8V/lux sec (550nm)
Angle of view	52° (horizontal) 42° (vertical)
Focus range	5m to infinity
Image transfer rate	36 fps
AUDIO SYNTHESIZER	
Spl minimum	86dB @ 10cm
EYEQ4® VISION PROCESSOR MAIN FEATURES	
Hyper-thread 64bit RISC interAptiv MIPS CPU	
1GB Ethernet Port (Service port for EyeNET)	
128MB Flash x2 (for code memory redundant)	
2 x 1.6GHz, 32bit LPDDR4 SDRAM interfaces	
4 x MIPI CSI-2 Rx serial video and image preprocessing	
1 x parallel video image preprocessing input port	
3 x CAN ports (>1Mbps)	
3 x UART ports (5Mbps)	
3 x I2C Interfaces	
MANUFACTURE STANDARD	
Mobileye 8 Connect manufactured in ISO/TS 16949	

Caution

Beware when removing the system after operation as it may be hot.

For your safety, please use gloves.

19.2 Mobileye® 8 series™ – 4G | Display unit Specification Sheet

EyeWatch Display Units		
PHYSICAL CHARACTERISTICS	EYEWATCH 3	EYEWATCH 8
Diameter	49mm	Width 84.5mm
Depth	66mm (leg open)	25mm Leg closed: 34mm Leg open: 73mm
Height	49mm	57mm
Weight	46g	109g without cable 146g with cable
Color	Black	Black
Case material	Plastic	Plastic & Aluminum
Cable length	3m	2.5m
Cable diameter	3mm (±0.2)	3mm (±0.2)
ELECTRICAL CHARACTERISTICS		
Input voltage	5VDC	10-36VDC
Input current	50mA	120mA @ 12V
AMBIENT TEMPERATURE (AS TESTED IN LAB WITH NO RADIATION EFFECT)		
Operation temperature	-20°C to +60°C	-20°C to +60°C
Storage temperature	-30°C to +85°C	-30°C to +85°C
Operating humidity	Up to 95%	Up to 95%
DISPLAY CHARACTERISTICS		
Screen size	1.5"	3.2"
Contrast ratio	250	500
Surface luminance	LCD full color – 40mcd (min)	900 cd/ m ²
Viewing angle	100°	45°/45°/45°/20°
Resolution	128 x 128 pixels	240 x 320 RGB
ADDITIONAL FEATURES		
Display colors		262k
Light sensor for automatic view day/night	Yes	Yes

19.3 Mobileye® 8 series™ – 4G | Cellular Module Specification Sheet

4G Cellular Module	
PHYSICAL CHARACTERISTICS	
Model	Telit LE910C1
Length	182mm
Width	55mm (slimmest); 78.6mm in connector area (peak)
Height	22MM
Weight	Modem unit: 121.9g Modem cable: 119.3g
Color	Black
Case material	PC/ABS
Cable length	3000mm (±30)
Cable diameter	6.5mm
SPECIFICATION	
Protocols	LTE FDD Cat1 (10/5Mbps DL/UL), GSM/GPRS/EDGE, WCDMA up to DC
Coverage area	Global with several models LE910C1-xx
Bands	2G: 2, 3, 5, 8 HSPA+: 1, 2, 3, 4, 5, 6, 8, 19 LTE FDD: 1, 2, 3, 4, 5, 8, 12, 13, 14, 18, 19, 20, 25, 26, 28, 28A, 66, 71
Data rates	Up to 10Mbit/s DL Up to 5Mbit/s UL
Internet protocols version	IPv4
Transport layer security	SSL – several TLS
Certification	WW – depend on each model. FCC /IC, PTCRB, (North America) RCM (Australia) Jade/Telec (Japan) RED/GCF (Europe) CCC/SRCC (China) Anatel (Brazil)
Telecommunications standards	TS 27.005, 27.007 and Telit Custom AT commands LTE FDD Cat.4, 3GPP release 10 compliant. LTE FDD Cat.1. 3GPP release 9 compliant
Serial interface	UART (up to 3Mbps)
Power supply	12V
Sim voltage	1.8V
Sim size	Nano SIM 10mm X 12.5mm x 1.2mm

19.4 Mobileye® 8 series™ – 4G | GNSS Technical Specification

RECEIVER TYPE	
Receive and track multiple systems	
Support satellite: GPS, GLONASS, BeiDou and QZSS signals	
FEATURES	
Frequency of time pulse signal	0.25 Hz...10 MHz
Module type	External module with antenna included
RTC using a crystal	External 32.768 kHz signal to the RTC input Clock and data backup on sleep mode
Voltage operation	1.65-3.6V
Dimension	53.5mm x 39.6mm x 17.1mm (width x length x height)
Cable length	2500mm (±50)

Mobileye 8 Series - Declaration of Conformity

Download the Mobileye 8 declaration of conformity documents from the Mobileye 8 section at

<https://www.mobileye.com/support/>